

## Cognito SM Series Uniball Upper Control Arms for 2015-2020 Ford F-150 4WD

**INSTALL INSTRUCTIONS:**

Cognito SM Series Uniball Upper Control Arms for 2015-2020 Ford F-150 4WD  
 SKU: 120-91056

**PARTS LIST FOR SKU: 120-91056**

QTY	PART #	DESCRIPTION
1	<b>80020</b>	Uniball Upper Control Arm Assembly, Driver
1	<b>80021</b>	Uniball Upper Control Arm Assembly, Pass.

**PARTS LIST FOR SKU: 80020**

QTY	PART #	DESCRIPTION
1	6446	1.25in Uniball Cap
1	8800	2015-2020 Ford F-150 Upper Control Arm, Driver
1	<b>91074</b>	2015-2020 Ford F150 Assembled Uniball Pin Kit (COM20)

**PARTS LIST FOR SKU: 80021**

QTY	PART #	DESCRIPTION
1	6446	1.25in Uniball Cap
1	8801	2015-2020 Ford F-150 Upper Control Arm, Pass.
1	<b>91074</b>	2015-2020 Ford F150 Assembled Uniball Pin Kit (COM20)

**WARNING**

Please read this entire instruction sheet before beginning installation. Proper installation of these components requires a qualified mechanic. Always wear safety glasses when using power tools, and take appropriate precautions when working under a vehicle. If these instructions are not properly followed you may jeopardize your, and your passenger's safety, and severe frame, suspension or tire damage may also result from improper installation.

**PARTS LIST FOR SKU: 91074**

QUANTITY	PART #	DESCRIPTION
1	UNI-BALL-COMH20T	Uniball COMH20T 1.25" w/ F-2 Fit & Teflon Liner.
1	<b>HP9338</b>	Replacement Uniball Pin Hardware Pack

**PARTS LIST FOR SKU: HP9338 (PRE-INSTALLED)**

ITEM NO.	QUANTITY	PART #	DESCRIPTION
1	1	6976	Uniball Pin
2	1	6445	Uniball Hat
3	1	HARDWARE-33626	1/2" Lock Washer
4	1	6952	12-point Castle Nut 1/2-20
5	1	HARDWARE-M12-FLATWASHER	M12 Flat Washer
6	1	HARDWARE-M12-1.5-CASTLNT	M12-1.5 Castle Nut
7	2	HARDWARE-COTTERPIN-1	Cotter Pin

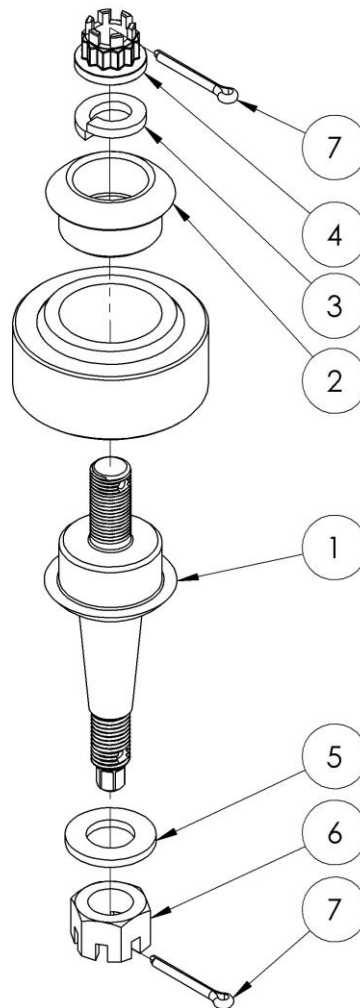
**ASSEMBLY OF UNIBALL PIN AND HARDWARE**



## INTRODUCTION

The Cognito Uni-Ball SM Series Upper Control Arm Kit is a direct replacement for the factory upper control arms (UCAs). The Cognito UCA kit will add performance due to a modified ball joint angle that eliminates travel limitations of the ball joint in leveled or lifted applications. The allowable droop travel is also improved with the design of these arms. Designed and made in the USA.

## TECH NOTES

- The stock wheel and tire will rub and are not compatible with this kit.
- Use of a 1.5-inch or greater wheel spacer is required.
- Trimming of inner fender well and bottom rear of steel fender may be required.
- CAM Brackets can be purchased separately that will allow for camber and caster adjustments
- Read instructions carefully and study the pictures (if included) before attempting installation.
- If this product was purchased as part of a bundle/package. Familiarize yourself with each set of instructions included with the bundle/package before beginning.
- Check the parts and hardware packages against the parts list to assure that your kit is complete before starting.

## REQUIREMENTS

- Installation requires a qualified mechanic.
- Follow the OE specifications when replacing or re-installing OE fasteners, retainers, and hardware specified in the OEM manual.
- Always wear safety glasses when using power tools.
- When a lift is required to perform the installation of these products and always ensure the vehicle is properly supported before attempting installation or serious injury may occur.

## INSTALLATION

1. Support the vehicle on a lift or on jack-stands and remove the front wheels and tires. **NEVER WORK ON AN UNSUPPORTED VEHICLE.**

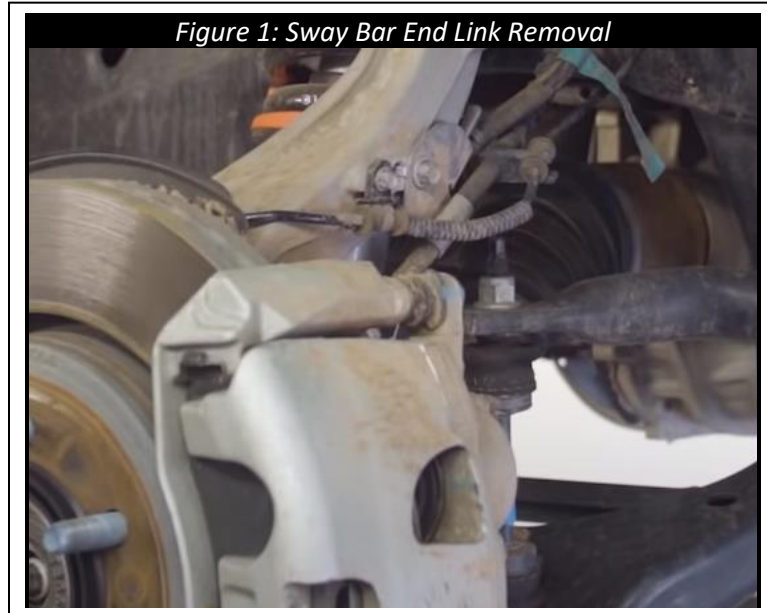

2. Remove the sway bar end link from the lower control arm. Place the hardware safely aside, it will be reused later.
3. Loosen the ball joint nut of the upper control arm (UCA), but do not remove totally. Use a pickle fork to separate the ball joint from the spindle or tap on the side of the spindle next to the ball joint stud. When the tapered seat of the ball joint breaks loose remove the ball joint nut, and separate the factory upper control arm from the spindle.



4. Remove the tie rod from the spindle. Loosen the tie rod nut, but leave the nut engaged on the tie rod by a few threads. Using a hammer, hit the end of the tie rod up to dislodge the tie rod from the spindle. Remove the tie rod from the spindle. Place the hardware safely aside, it will be reused later.

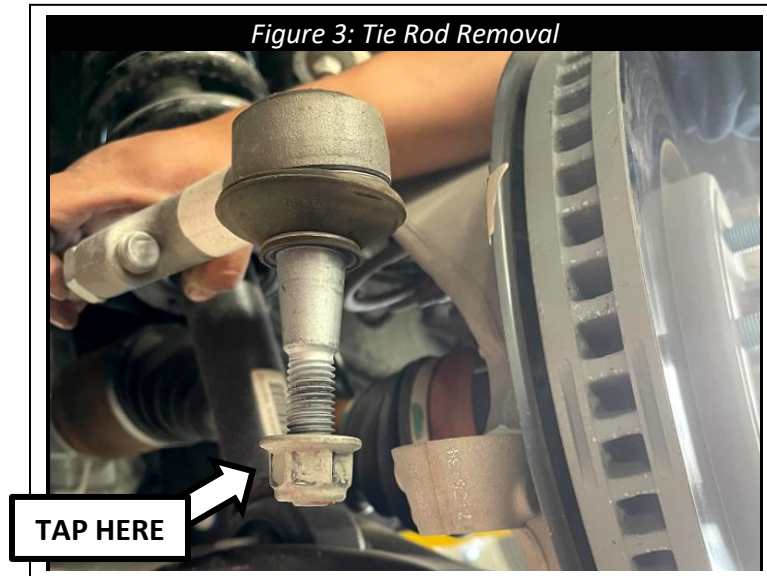

5. Using a marker, mark the alignment of the lower control arm (LCA) pivot bolts on both the bolt head and nut side of the frame.

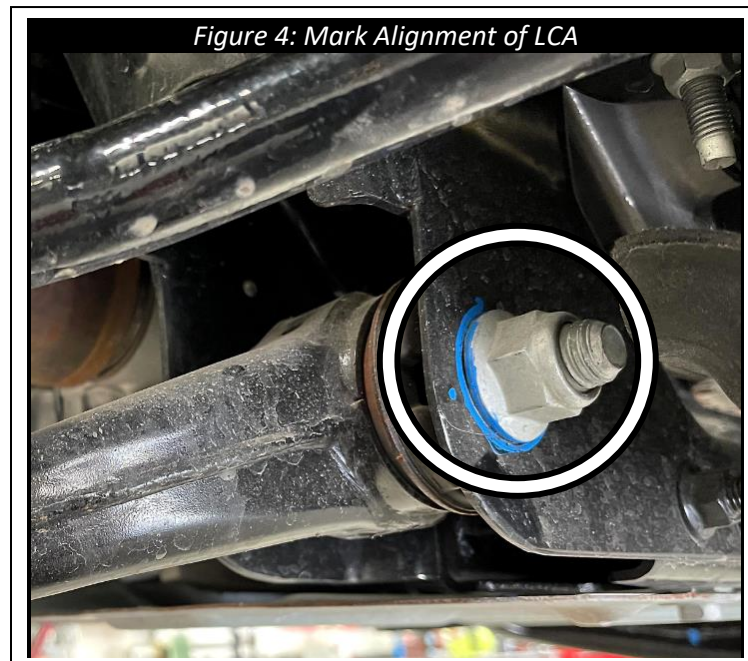



6. Remove the strut's two lower nuts underneath the LCA. Place the hardware safely aside, it will be reused later.

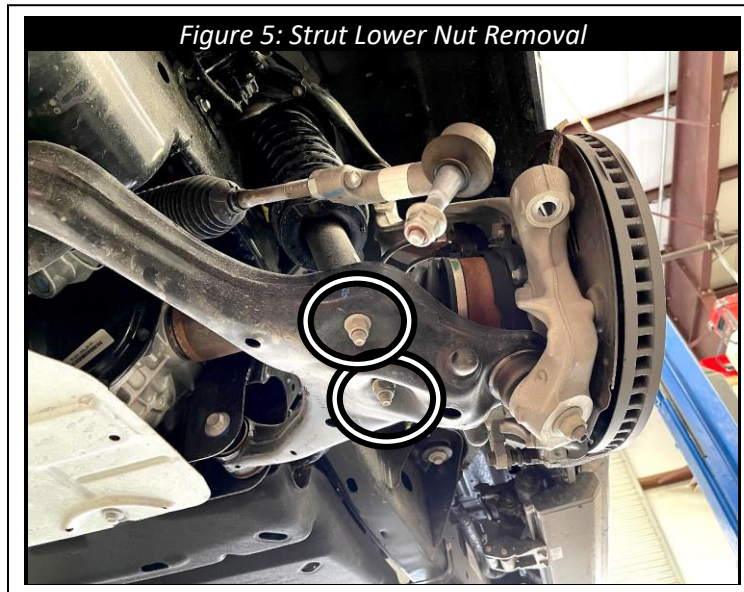

7. Remove the LCA pivot bolts. Swing the LCA downward and free of the strut. Place the hardware safely aside, it will be reused later.

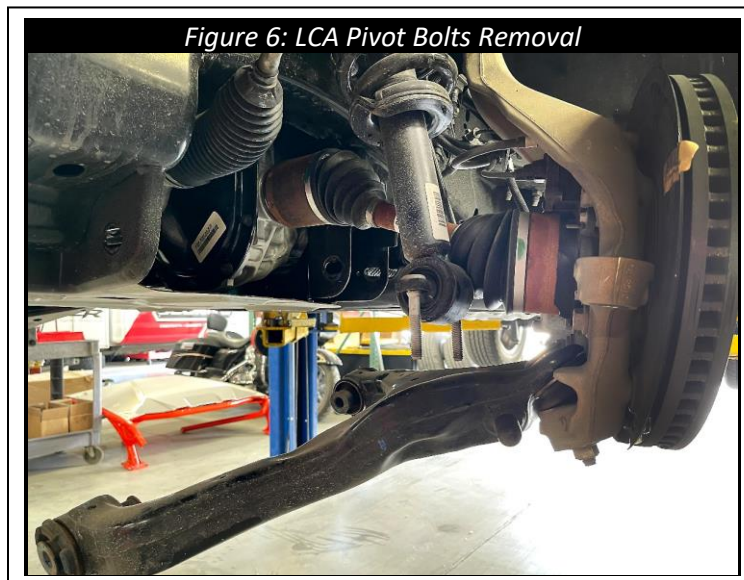

8. Remove the strut from the vehicle. Remove the 3x nuts on top of the strut to free the strut from the frame.

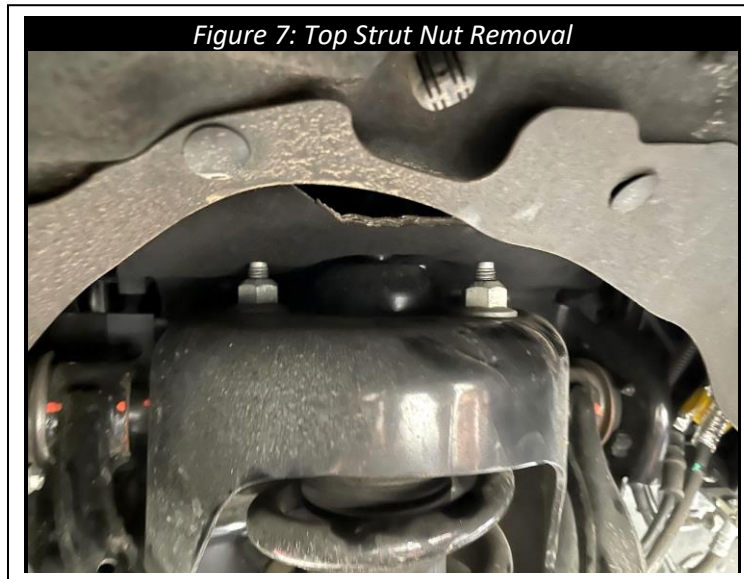

9. Reattach the LCA to the frame using the pivot bolts that were removed in a previous step.

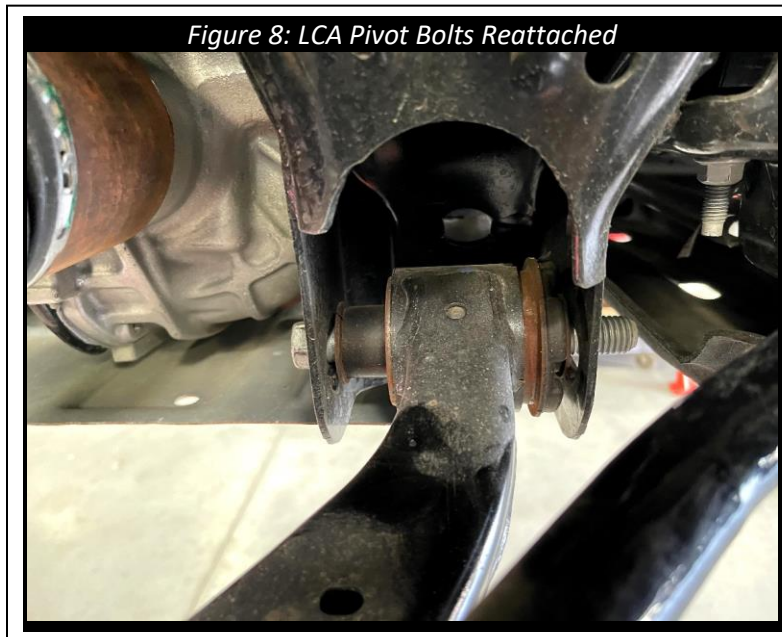

10. Place a jack under the spindle for support before proceeding to the next step.

**NOTE:** It is critical to support the spindle assembly when the UCA is removed and there is no shock holding the spindle assembly.

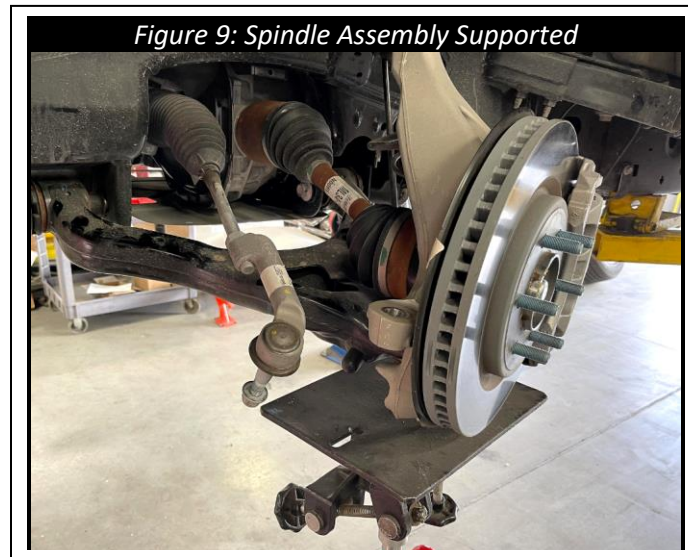

11. Remove the nut holding the UCA to the spindle and remove the UCA from the spindle. Ensure that the spindle does not fall over or put tension on the ABS sensor wire and the brake lines.

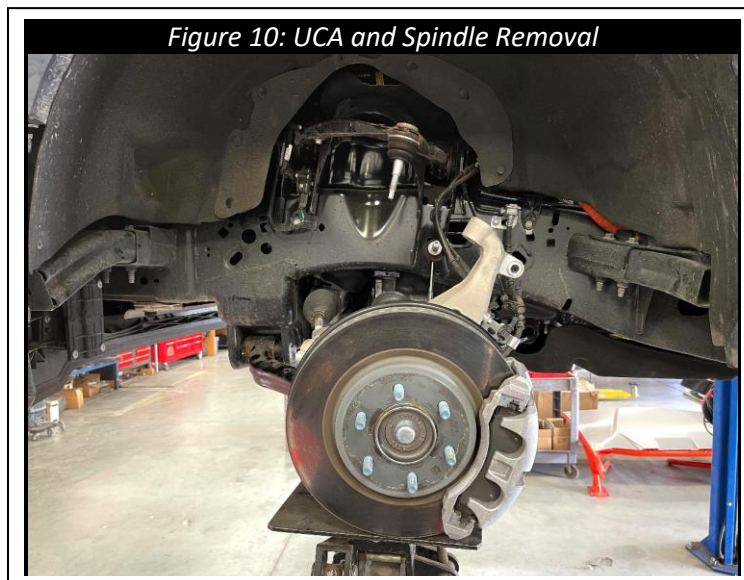



12. Remove the UCA pivot bolts and remove the UCA from the frame.

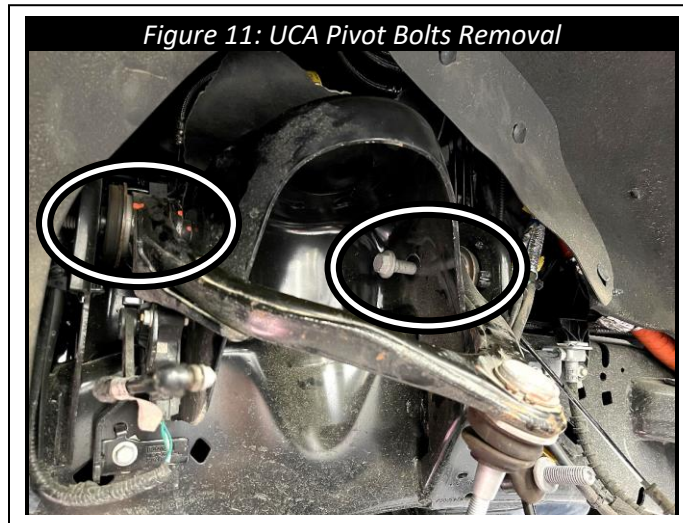

13. Install the Cognito SM Series UCA to the frame using the factory hardware.
14. If you have also purchased a set of Cognito strut spacers or shocks, install them now referring to the instruction sheet included in that kit. Otherwise, reinstall the factory strut using the factory hardware in the same orientation it was removed. Torque the factory hardware to factory specifications.



15. Mount the uniball pin to the spindle with the M12 castle nut. Use the flat washers supplied if the castle nut needs to be spaced down for the cotter pin to engage with its castellations. Torque the nut to **60 ft-lbs**. Install cotter pin and bend to lock into place. If the castellations in the castle nut and the hole in the uniball pin do not align once torqued to **60 ft-lbs**, continue tightening the nut until the two are aligned and the cotter pin can be installed. **NEVER LOOSEN THE NUT TO GET THE CORRECT ALIGNMENT!**



16. Torque the UCA pivot bolts to **100 ft-lbs**.





17. Repeat the steps above to install the Cognito UCA onto the opposite side of the vehicle.
18. Ensure that all bolts are properly torqued. Ensure there are no rubbing or loose cables anywhere after the Cognito UCA installation. Use cable ties to restrain any cables from interfering with any other part. Check that all lines are free of stress or interference while the vehicle is in full droop, full bump, and throughout the complete steering cycle.
19. Install aftermarket front wheels and tires. Torque lug nuts to the factory manufacturer's specifications.
20. Before lowering the vehicle, measure from the top of the wheel well directly above the center line of the wheel to the top of the tire, (Figure 16). Record this measurement as (A) in Table 1. Subtract 3 inches from A and record this number.

**NOTE:** It can be helpful to place a piece of painter's tape at the top of the wheel well directly above the centerline of the wheel and measure from there.

21. Set the truck on the ground and drive forward and backward a few times to settle the suspension. Measure again from the top of the tire to the top of the wheel well as in the step above and record this measurement as (C) in Table 1.

**NOTE:** If (C) is larger than (B), the ride height is too tall. This can be caused by shocks or shock spacers that are too long, stacked shock spacers, spring preload devices, or any combination of the above.

Failure to use compatible shocks to limit the vehicles front suspension may cause over-extension, which as a result can cause damage to ball joints, uni-balls, tie rods, and/or CV axles, along with other related safety issues.

***Warranty on Cognito products will be void if the vehicles front suspension is not properly limited to the above max ride height calculation.***

Suspension Travel	Record	Measurement (Inches)
Full Droop	A	
Max Ride Height	$B = A - 3 \text{ in}$	
Ride Height	C	

**Table 1.** Suspension Travel Measurements

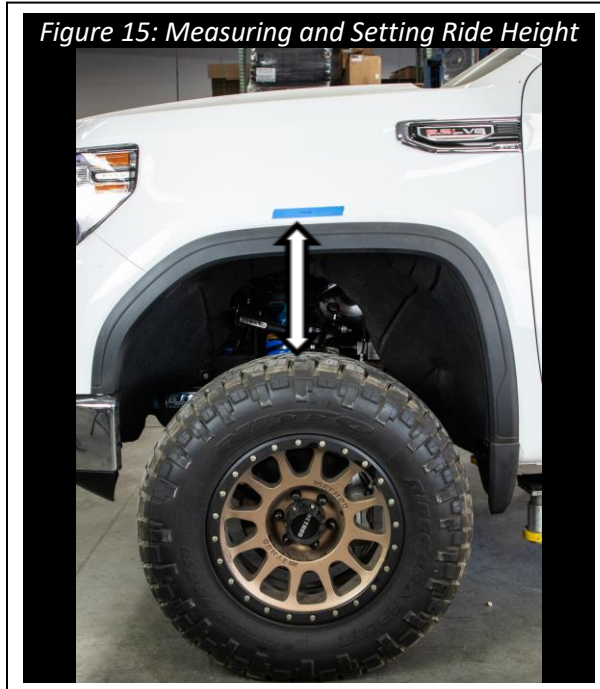

22. Once the ride height has been set, adjust headlights per owner's manual.

23. Have the vehicle professionally aligned.

**NOTE:** Some Cognito upper control arms have added caster built into them to increase drivability performance, therefore it's important to be sure the correct control arm is installed on the correct side of the vehicle. It's also important to make your alignment shop aware that if caster is higher than normal for OEM, that is the intention by design.

Cross caster is important in making your vehicle track straight down the road. Most roads have crown to them, high in the middle for water runoff. This crown will make your vehicle want to pull to the right. Vehicles with stock tires on them have a narrow contact patch on the ground and are not as affected as a vehicle having larger wider tires. With larger wider tires it's important to have cross caster proper in order for the vehicle to track straight on these roads. Trucks with dual rear wheels have more tire on the ground and require more cross caster. The length of the wheelbase will also affect cross caster needed.

Generally, crew cab short and long bed trucks like .8 degrees of cross caster. For example, the driver side would have 2° while the passenger side would have 2.8° of caster. Dual rear wheel trucks like .9-1.0 degrees of cross caster. Your area might have roads that are crowned more or less than average therefore these numbers may need to change, and your alignment shop should understand this. If your alignment tech is stating they can't align the truck, that typically means they can't get the alignment to OEM spec, and that's fine because your vehicle is no longer OEM. A good tech will understand this and the numbers and let caster run slightly out of OEM spec (Caster should always be above 2 degrees positive) while maintaining cross caster needed for the vehicle and roads so you enjoy your vehicle with aftermarket Cognito parts and your driving experience. Camber should always be from  $-1^{\circ}$  to  $+1^{\circ}$  and toe should always be .125" to .250" toe in for best tire wear.

***This completes the installation steps, enjoy your new Cognito SM Series Uniball Upper Control Arm Kit!***



## WARRANTY / RETURN POLICY / SAFETY

### **Cognito Limited Lifetime Warranty**

Cognito Motorsports, Inc. hereinafter “Cognito,” warrants to the original retail purchaser, that its suspension products are free from workmanship and material defects for as long as the purchaser owns the vehicle on which the product(s) were originally installed. This warranty will be void if any modifications are made to the components, including alterations to the surface finish, i.e.; painting, powder coating, plating, and/or welding, or if they are improperly installed. Cognito truck suspension products are not designed nor intended to be installed on “competition” vehicles used in race applications, stunt or for exhibition purposes that are outside of the intended operating conditions specified by the manufacturer. Racing and competition are defined as any contests between two or more vehicles; or vehicles competing individually on off road circuits in timed events (whether or not such contests are for an award or prize).

This warranty does not include coverage for police, taxi, government or commercial vehicles, and the warranty does not cover Cognito products sold outside of the USA. Cognito’s obligations under this warranty are specified and applied at its sole discretion, and warranty coverage is limited to repair or replacement of the defective product(s). Any and all costs of removal, installation or reinstallation; freight charges, incidental or consequential damages associated with the covered products are expressly excluded from this warranty.

The following items are exempt from Cognito limited warranty coverage: bushings, bump stops, tie-rod ends (Heim joints) and limiting straps. These parts are “consumables” and designed to wear as a normal part of their duty cycle, therefore they are not considered defective when worn. The aforementioned products are warrantied separately against defects in workmanship, for 60 days from the date of purchase. As a condition of warranty validation, respective Cognito suspension components must be installed as a complete system (not combined with non-Cognito hardware or ancillary parts). Any substitutions or omission of required components will void the warranty. Some minor cosmetic wear and imperfections may occur to parts during shipping, which is not covered under this warranty. This limited warranty does not apply to any components that have been subjected to collision damage, negligence, alteration, abuse, or misuse, and coverage does not extend to products manufactured by third-party companies. Cognito reserves the right to supersede, discontinue, or change the design, finish, part number and/or application of its parts when deemed necessary, without notice.

### **Return Policy**

Product returns will not be accepted without prior written approval from an authorized Cognito representative. All products being returned must be shipped via trackable, prepaid freight. Returned products are subject to a 25% percent restocking fee. The eligible return period for products purchased directly from Cognito is 30 days from the verified date when the product(s) were originally received by the purchaser.

### **Product Safety Advisory**

The installation of Cognito steering and suspension components will modify your vehicle’s original factory equipment and geometry, which may cause it to handle differently than a stock (unaltered) vehicle. Installation of these components is not intended to strengthen nor reinforce the vehicle’s frame, nor are they designed to increase rollover protection. It is necessary to periodically inspect all suspension and drive train components for proper attachment, torque specifications, operation, and for any potential unusual wear or damage. Installation of these parts will modify the height of the vehicle and may raise the center of gravity. Modifying vehicle height combined with off road operation may increase your vehicle’s susceptibility to rollover conditions, which may cause serious injury or death. Many states regulate allowable vehicle height modifications, and it is your responsibility to know and comply with the legal requirements specified by the laws where you reside. Modifications to your vehicle’s ride height may also affect the ride quality, driver input response, trackability and handling, and wear to your vehicle’s suspension components and tires.





This page intentionally left blank.