

100C Air Compressor Kit

- 10010 – 100C Air Compressor (standard mounting bracket, CE Certified)
- 10014 – 100C Air Compressor (no leader hose or check valve, CE Certified)
- 10016 – 100C Air Compressor (with Omega Bracket, CE Certified)
- 10019 – 100C Air Compressor Stealth Black (with Omega Bracket, CE Certified)

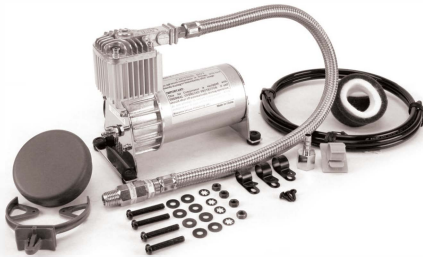

100C - P/N 10010



100C - P/N 10014



100C - P/N 10016



100C - P/N 10019 Stealth Black



P/N 10010
10014
10016

IMPORTANT:

It is essential that you and any other operator of this product read and understand the contents of this manual before installing and using this product.

SAVE THIS MANUAL FOR FUTURE REFERENCE

USER MANUAL



P/N 10010
10014
10016
10019

100C Air Compressor Kit

IMPORTANT SAFETY INSTRUCTIONS

CAUTION - To reduce risk of electrical shock or electrocution:

- Do not disassemble. Do not attempt repairs or modifications. Refer to qualified service agencies for all service and repairs.
- Do not use this product in an area where it can fall or be pulled into water or other liquid.
- Do not reach for this product if it has fallen into liquid.
- Use this compressor with 12-volt DC systems only.
- This product should never be left unattended during use.

WARNING - To prevent injury:

- Never allow children to operate this compressor. Close supervision is necessary when this compressor is being used near children.
- This compressor will become very hot during and immediately after use. Do not touch any part of this compressor with bare hands during and immediately after use.
- Do not use this product near flames or explosive materials or where aerosol products are being used.
- Do not operate this product where oxygen is being administered.
- Do not pump anything other than atmospheric air.
- Never use this product while sleepy or drowsy.
- Do not use any tools or attachments without first determining maximum air pressure for that tool or attachment.
- Never point any air nozzle or air sprayer toward another person or any part of the body.
- This air compressor is equipped with Automatic Reset Thermal Protector, and can automatically restart after the thermal protector resets. Always cut off power source when thermal protector becomes activated.
- Wear safety glasses or goggles when operating this product.
- Use only in well ventilated areas.

INSTALLATION

Please read and follow the installation instructions carefully to avoid injury or damage to the compressor and your vehicle. Each of our air compressors and parts have been carefully produced and packaged. Before you begin installation, please familiarize yourself with Installation Parts List (Fig. 1) of this manual.

Guidelines for Selecting Mounting Location:

The selection of proper mounting location for your air compressor will help ensure a long and trouble free compressor service life. Please pay close attention to the following guidelines:

1. Select a FLAT, UPRIGHT, AND SECURE location where the compressor can be mounted.
2. To maximize air compressor performance, locate compressor as CLOSE TO THE BATTERY as possible so that length of positive lead wire required is at a minimum.
3. Choose mounting location that is as cool as possible and AWAY FROM HEAT SOURCES. The cooler the ambient temperature the less chance the compressor will overheat.
4. This compressor is moisture & splash resistant, but NOT WATER PROOF. Do not mount compressor in locations where the unit is likely to come in contact with water.
5. Select compressor mounting location where air line can be routed from compressor air inlet to remote inlet air filter. Make sure Remote Inlet Air Filter is located in a dry location, away from water splashes.
6. You will also want to select compressor mounting location where the leader hose bracket can be mounted to secure the leader hose. (NOTE: P/INs 10014 / 10016 / 10019 are not equipped with a leader hose).
7. If it is necessary to mount the air compressor further away from the battery, such as inside your vehicle or in the bed of your pickup, use a minimum 10 AWG positive lead wire for remote installation. (See wire gauge reference chart)
8. Do not mount compressor near areas where flammable liquids are stored.
9. Use thread sealant for proper fitting installation. Thread tape is not recommended. Properly sealed, recommended torque is 12 to 15 ft. lbs

100C Air Compressor Kit

MOUNTING AND WIRING

1. Disconnect ground cable from vehicle's battery.
2. Temporarily position the air compressor in the location where it will be mounted.
3. Route ground wire to the negative post of the battery or to an appropriate grounding point and cut ground wire to length as needed.
4. Mount air compressor with the four sets of bolts, nuts, washers, and locking washers provided. (See Fig. 2 for Mounting Instructions)
5. Refer to Remote Air Filter Installation Instructions included in the Remote Inlet Air Filter Pack.
6. This air compressor may be equipped with a heat resistant leader hose (Not applicable to P/Ns 10014 / 10016 / 10019). This leader hose is designed to prolong the life of your air line. Do not remove this leader hose from air compressor.
7. Please note, the leader hose that came with your compressor may have a built-in inline check valve installed. Do not remove inline check valve from leader hose if so equipped.
8. If equipped, select a proper location to mount leader hose with hose bracket provided. Avoid locations where leader hose may become tangled with wires and other hoses.
9. To mount hose bracket, drill hole with 3/16" drill bit and push self-anchoring hose bracket pin into hole. Route leader hose through hose bracket and secure hose by pressing bracket clamp into locked position.
10. To remove hose from the hose bracket, simply press down on the hose clamp release tab to release bracket clamp. (Fig. 3)
11. Connect compressor positive lead wire to one of the leads of your pressure switch.
12. Make sure that your compressor setup is properly fused. For appropriate fuse size, refer to amp draw of compressor in the Specifications section of this manual.
13. Always locate fuse as close as possible to power source.
14. Before connecting to power source, re-check to make sure that all connections are properly connected.
15. Connect and test compressor system by running the compressor for a short time to build up pressure in your air tank.
16. Once air pressure reaches preset cut out pressure of your pressure switch, the compressor will shut off. Inspect all air line connections for leaks with soap and water solution. If a leak is detected, the air line may not be cut squarely or pushed all the way in. Tighten connections if needed.

(Fig. 1) Air Compressor Kit Installation Parts List:

100C - P/N 10010, & 10014

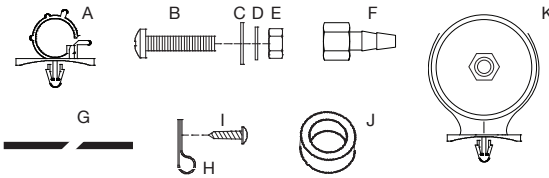

- A. Hose Bracket (1pc) (P/N 10010 only)
- B. Mounting Bolts (4pcs)
- C. Flat Washers (8pcs)
- D. Locking Washers (4pcs)
- E. Nuts (4pcs)
- F. 1/4" NPT F x 1/4" Barbed Fitting (1pc)
- G. 1/4" Air Line (1pc)
- H. Air Line Clips (3pc)
- I. Screws (3pc)
- J. Air Filter Element (2pcs)
- K. Remote Inlet Air Filter with Filter Element (1pc)

100C - P/N 10016, & 10019

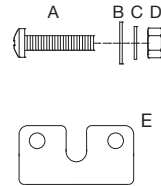

- A. Mounting Bolts (4pcs)
- B. Flat Washers (8pcs)
- C. Locking Washers (4pcs)
- D. Nuts (4pcs)
- E. Vibration Isolator (4pcs)

100C Air Compressor Kit

(Fig. 2) Compressor Mounting Hardware

- B. Mounting Bolt
- C. Flat Washer
- D. Locking Washer
- E. Nut
- K. Vibration Isolator

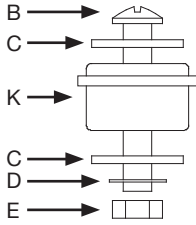

(Fig. 3) Leader Hose Bracket

- L. Hose Clamp
- M. Clamp Release Tab
- N. Self Anchoring Pin

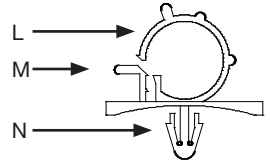

OPERATING INSTRUCTIONS

1. **IMPORTANT:** Always operate the compressor at or below the **MAXIMUM PRESSURE RATING** of the compressor. Please refer to Application & Specifications Section of this manual for details.
2. Always observe the **MAXIMUM DUTY CYCLE** of the air compressor. Refer to Compressor Applications and Specification Sections of this manual for details. Operation exceeding maximum pressure ratings and/or duty cycle will result in damage to the air compressor.
3. Your air compressor is equipped with an **AUTOMATIC THERMAL OVERLOAD PROTECTOR**. This feature is designed to protect the air compressor from overheating and causing permanent damage to your air compressor. The thermal overload protector will automatically cut power to your air compressor should the internal operating temperature of the air compressor rise above safe levels during excessive use.
4. Should at any time during use, your air compressor automatically shuts off; do not attempt to restart the air compressor. Turn off power and allow unit to cool for about 30 minutes. This will allow the Thermal Overload Protector to reset so you can safely resume use of the air compressor.
5. To prevent discharge of your vehicle's battery, and enhance performance, keep the vehicle's engine running while using the compressor.
6. Only operate compressor in well ventilated areas.
7. The use of a relay is strongly recommended for installation of this compressor, but is not included. (40-amp relay value or higher).

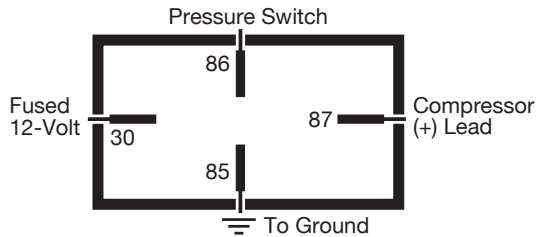

RELAY WIRING SCHEMATIC

100C Air Compressor Kit

MAINTENANCE & REPAIRS

1. Periodically check all electrical and fitting connections. Clean and tighten as needed.
2. Periodically check all mounting screws. Tighten as needed.
3. Replace air filter element periodically. Replacement frequency depends on operating frequency and operating environment. For frequent use in dusty environments, we recommend that you replace air filter element at least once a month.
4. Regularly clean dust and dirt from compressor cooling fins and motor housing.
5. Your air compressor is equipped with permanently lubricated, maintenance-free motor. Never try to lubricate compressor.
6. All repairs should be performed by Manufacturer or Manufacturer's Authorized Service Agencies only.

CAUTION:

Never touch the air compressor or fittings connected to the air compressor with bare hands during or immediately after use. Leader hose and fittings connected to Leader Hose will become very hot during and after use. If necessary, wear heat resistant gloves to handle fittings, air line, and leader hose.

SPECIFICATIONS

100C AIR COMPRESSOR PART NUMBERS:

- Part No. 10010 / 100C Air Compressor (standard mounting bracket, CE Certified)
- Part No. 10014 / 100C Air Compressor (no leader hose or check valve, CE Certified)
- Part No. 10016 / 100C Air Compressor (with Omega Bracket, CE Certified)
- Part No. 10019 / 100C Air Compressor Stealth Black (with Omega Bracket, CE Certified)

Motor Voltage:	12 volts
Motor Type:	Perm. Magnetic
Max. Working Pressure:	130 PSI
Max. Duty Cycle:	15%
(Min. On/Off @72°F & 100 PSI)	9 On / 51 Off
Continuous Use@72°F & 30 PSI:	30 Minutes
Max. Restart Pressure:	180 PSI
Max. Current Consumption:	14 Amps
Fuse:	20-amp
Max. Ambient Temperature:	158°F
Min. Ambient Temperature:	-40°F
Auto. Reset Thermal Protection:	Yes

100C Air Compressor Kit

COMPRESSOR APPLICATION GUIDE

To ensure that you get the highest level of satisfaction from your compressor performance, refer to information below:

VIAIR COMPRESSOR REFERENCE CHART

COMPRESSOR SERIES	MAX. WORKING PRESSURE	DUTY CYCLE (100 PSI @ 72°F)
090 SERIES	120 PSI	9%
092 SERIES	120 PSI	9%
095 SERIES	120 PSI	9%
097 SERIES	130 PSI	10%
098 SERIES	130 PSI	10%
100 SERIES	130 PSI	15%
250 IG SERIES	150 PSI	100%
275 SERIES	150 PSI	25%
280 SERIES	150 PSI	30%
325 SERIES	150 PSI	33%
330 IG SERIES	150 PSI	100%
350 SERIES	150 PSI	100%
380 SERIES	200 PSI	100%
		55% @ 200 PSI
400 SERIES	150 PSI	33%
420 SERIES	150 PSI	33%
425 SERIES	175 PSI	33% @ 175 PSI
		50%
444 SERIES	200 PSI	100%
		50% @ 200 PSI
450 SERIES	150 PSI	100%
450 IG SERIES	150 PSI	100%
460 SERIES	150 PSI	100%
480 SERIES	200 PSI	100%
		50% @ 200 PSI
485 SERIES	200 PSI	100%
		100% @ 200 PSI

ABOUT COMPRESSOR DUTY CYCLE:

Duty cycle refers to the amount of time a compressor can be operated in a given time period at 100 PSI, and a standard ambient temperature of 72° F. It is commonly expressed in percentage format: Compressor on time ÷ (on time + off time) = Duty Cycle %.

ONE-HOUR DUTY CYCLE

(100 PSI @ 72°F)

9%	5 Min. On / 55 Min. Off
10%	6 Min. On / 54 Min. Off
15%	9 Min. On / 51 Min. Off
20%	12 Min. On / 48 Min. Off
25%	15 Min. On / 45 Min. Off
30%	18 Min. On / 42 Min. Off
33%	20 Min. On / 40 Min. Off
50%	30 Min. On / 30 Min. Off
100%	1 Hour Run Time

MINUTES ON / MINUTES OFF

NOTE: All compressors, regardless of rated duty cycle, require sufficient rest time in between cycles to allow for partial or complete heat dissipation. Heat dissipation rates may vary depending on ambient temperatures and operating conditions.

ABOUT RATED WORKING PRESSURE:

To ensure trouble free service life of your compressor, always operate compressor within rated working pressure of the compressor. Never use a pressure switch with a higher cut-off pressure than compressor's rated working pressure.

100C Air Compressor Kit

TROUBLESHOOTING GUIDE:

PROBLEM:	POSSIBLE CAUSE(S)	CORRECTIVE ACTION
Tank pressure drops when compressor(s) shut off	<ol style="list-style-type: none">1. Loose drain cock2. Check valve leaking3. Loose connections	<ol style="list-style-type: none">1. Tighten drain cock2. Replace check valve or compressor3. Check all connections with soap and water solution and tighten
Compressor runs continuously and air flow lower than normal	<ol style="list-style-type: none">1. Excessive air usage2. Loose connections3. Worn piston ring or inlet valve.4. Clogged air filter element	<ol style="list-style-type: none">1. Decrease air usage2. Check all connections with soap and water solution and tighten.3. Replace compressor4. Replace air filter element
Compressor runs continuously causing safety valve (if equipped) to open	<ol style="list-style-type: none">1. Faulty pressure switch2. Defective safety valve	<ol style="list-style-type: none">1. Replace pressure switch2. Replace safety valve
Excessive moisture in discharge	<ol style="list-style-type: none">1. Excessive water in air tank2. High humidity	<ol style="list-style-type: none">1. Drain tank, tilt tank to drain. Drain tank more frequently2. Move compressor to area with less humidity, or use water separator
Compressor will not run	<ol style="list-style-type: none">1. No power, or power switch in OFF position2. Blown fuse3. Motor overheats4. Faulty pressure switch (if hooked up to a pressure switch).	<ol style="list-style-type: none">1. Make sure compressor switch is ON2. Disconnect compressor from power source, replace fuse. (Refer to Specifications section for correct fuse amperage)3. Let compressors cool off for about 30 minutes to allow thermal overload switch to reset.4. Replace pressure switch
Thermal overload protector cuts out repeatedly	<ol style="list-style-type: none">1. Lack of proper ventilation or ambient temperature is too high2. Compressor valves failed	<ol style="list-style-type: none">1. Move compressor to well ventilated area, or area with lower ambient temperature2. Replace compressor
Excessive knocking or rattling	<ol style="list-style-type: none">1. Loose mounting bolts2. Worn bearing on eccentric or motor shaft3. Cylinder or piston ring is worn	<ol style="list-style-type: none">1. Tighten bolts2. Replace bearing or piston assembly3. Replace piston or compressor

CAUTION: NEVER DISASSEMBLE COMPRESSOR WHILE COMPRESSOR IS PRESSURIZED.

100C Air Compressor Kit

AMERICAN WIRE GAUGE GUIDE 12-VOLT:

Amp Draw	Length of wire from battery to compressor (in feet)			
	5	10	15	20
5	16	16	16	14
10	16	14	12	10
15	16	12	10	10
20	14	10	10	8
25	14	10	8	6
30	12	10	8	6
40	12	8	6	6
50	10	6	6	4
60	10	6	4	4

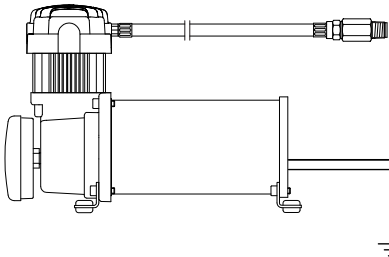

Wiring Diagram:
(Fuse Not Included)

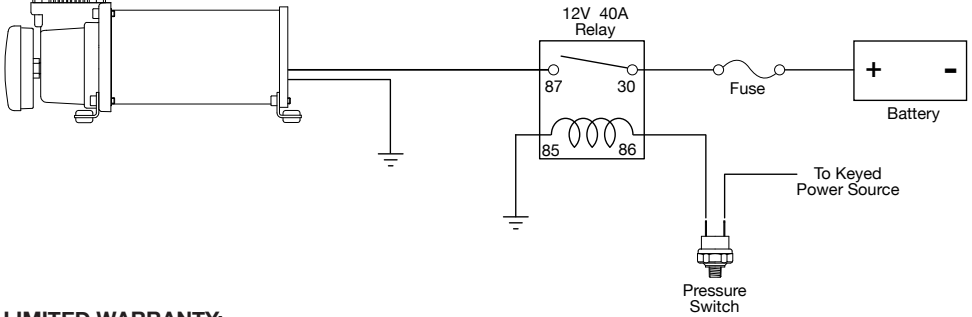

LIMITED WARRANTY:

VIAIR Corporation warrants this product, when properly installed and under normal conditions of use, to be free from defects in workmanship and materials for a period of one year from its original date of purchase. To receive warranty service or repair, please contact VIAIR Corporation.

Returns should be made within one year of the date of purchase, after a Return Goods Authorization (RGA) number has been assigned by VIAIR Corporation. To obtain RGA, fax a copy of your receipt to (949) 585-0188. For complete warranty details, please visit: www.viaircorp.com/warranty

PLEASE NOTE:

THIS WARRANTY COVERS PRODUCT DEFECTS ONLY; IT DOES NOT COVER INCIDENTAL OR CONSEQUENTIAL DAMAGES AS RESULT OF MISUSE OR ABUSE.

This Manual is proprietary to VIAIR Corporation and no ownership rights are hereby transferred. No part of the Manual shall be used, reproduced, translated, converted, adapted, stored in a retrieval system, communicated or transmitted by any means, for any commercial purpose, including without limitation, sale, resale, license, rental or lease, without the prior express written consent of VIAIR. VIAIR does not make any representations, warranties or guarantees, express or implied, as to the accuracy or completeness of the Manual. Users must be aware that updates and amendments will be made from time to time to the Manual. It is the user's responsibility to determine whether there have been any such updates or amendments. Neither VIAIR nor any of its directors, officers, employees or agents shall be liable in contract, tort or in any other manner whatsoever to any person for any loss, damage, injury, liability, cost or expense of any nature, including without limitation incidental, special, direct or consequential damages arising out of or in connection with the use of the Manual.



15 EDELMAN • IRVINE, CA 92618
TEL: (949) 585-0011 • FAX: (949) 585-0188
www.viaircorp.com

USER MANUAL

R1-120820