

# ROUGH COUNTRY

## SUSPENSION SYSTEMS®

### GM 2019-2024 2WD/4WD 1500 6" Lift Kit

Thank you for choosing Rough Country for your suspension needs.

Rough Country recommends a certified technician install this system. In addition to these instructions, professional knowledge of disassemble/reassembly procedures as well as post installation checks must be known. Attempts to install this system without this knowledge and expertise may jeopardize the integrity and/or operating safety of the vehicle.

Please read instructions before beginning installation. Check the kit hardware against the parts list on the rear cover of these instructions. Be sure you have all needed parts and know where they go. Also please review tools needed list and make sure you have needed tools.

#### PRODUCT USE INFORMATION

**▲WARNING** As a general rule, the taller a vehicle is, the easier it will roll. Seat belts and shoulder harnesses should be worn at all times. Avoid situations where a side rollover may occur. Generally, braking performance and capability are decreased when larger/heavier tires and wheels are used. Take this into consideration while driving. Do not add, alter, or fabricate any factory or after-market parts to increase vehicle height over the intended height of the Rough Country product purchased. Mixing component brands is not recommended.

Rough Country makes no claims regarding lifting devices and excludes any and all implied claims. We will not be responsible for any product that is altered. If question exist we will be happy to answer any questions concerning the design, function, and correct use of our products.

**▲NOTICE** The electric power steering must be unplugged before any of the steering components are removed. Failure to do so may cause damage to the electric power steering.

**▲NOTICE** Trucks equipped with a mass damper on the front diff, the damper will have to be removed.

This kit is packaged as a leveling kit—raising the front 6" and the back 5.5". If you desire a different look or if the vehicle has a tool box or added weight in the rear, please consult with your sales representative about other block and u-bolt options.

This suspension system was developed using a 35" x 12.5" tire with 20" x 9" wheel and a offset of -12mm or -6mm offset with a 1/4" wheel spacer. 20x10 wheels require -24mm offset or -18mm offset with a 1/4" wheel spacer. **Max backspacing of 4.5"**. If wider tires are used trimming may be required.

**▲NOTICE** Fits crew cab short bed models only.

#### ▲NOTICE DEALER AND VEHICLE OWNER

Any vehicle equipped with any Rough Country product should have a "Warning to Driver" decal installed on the inside of the windshield or on the vehicle's dash. The decal should act as a constant reminder for whoever is operating the vehicle.

#### Tools Needed:

|                         |                      |
|-------------------------|----------------------|
| Floor Jack /Jack Stands | 36mm socket          |
| 10mm socket /wrench     | 1/2" socket/wrench   |
| 13 mm socket/wrench     | 9/16" socket /wrench |
| 15mm socket / wrench    | 3/4" socket/wrench   |
| 17mm socket/wrench      | #30 Torx bit         |
| 18mm socket /wrench     | Reciprocating Saw    |
| 21mm socket /wrench     | Hammer               |
| 22mm socket /wrench     | Locking Pliers       |
| 24mm socket /wrench     |                      |
| 27mm socket /wrench     |                      |

#### Torque Specs:

| Size  | Grade 5   | Grade 8   | Size | Class 8.8 | Class 10.9 |
|-------|-----------|-----------|------|-----------|------------|
| 5/16" | 15 ft/lbs | 20ft/lbs  | 6MM  | 5ft/lbs   | 9ft/lbs    |
| 3/8"  | 30 ft/lbs | 35ft/lbs  | 8MM  | 18ft/lbs  | 23ft/lbs   |
| 7/16" | 45 ft/lbs | 60ft/lbs  | 10MM | 32ft/lbs  | 45ft/lbs   |
| 1/2"  | 65 ft/lbs | 90ft/lbs  | 12MM | 55ft/lbs  | 75ft/lbs   |
| 9/16" | 95 ft/lbs | 130ft/lbs | 14MM | 85ft/lbs  | 120ft/lbs  |
| 5/8"  | 135ft/lbs | 175ft/lbs | 16MM | 130ft/lbs | 165ft/lbs  |
| 3/4"  | 185ft/lbs | 280ft/lbs | 18MM | 170ft/lbs | 240ft/lbs  |

## Kit Boxes

### 27531 (4" AT4/Trailboss w/ N3 Rr Shocks):

217BOX1A  
217BOX11  
217BOX3  
217BOX4  
21730BOX5  
21730BOX6  
23158

### 21731 (6" Kit w/ N3 Rr Shocks)

217BOX1A  
217BOX11  
217BOX3  
10900BOX2  
21730BOX5  
21730BOX6  
23158

### 21732 (6" Kit w/ N3 Struts & N3 Rr Shocks):

217BOX1A  
217BOX11  
217BOX3  
21730BOX5  
21730BOX6  
649067 x 2  
23158

### 21750 (6" Kit w/ Fr & RR Vertex Shocks):

217BOX1A  
217BOX11  
217BOX3  
21730BOX5  
2130BOX6  
680017L  
680017R  
690001 x 2

### 21770 (6" Kit w/ V2 Rr Shocks):

217BOX1A  
217BOX11  
217BOX3  
10900BOX2  
21730BOX5  
21730BOX6  
760748

### 21771 (6" Kit w/ N3 Struts & V2 Rr Shocks):

217BOX1A  
217BOX11  
217BOX3  
21730BOX5  
21730BOX6  
649067 x 2  
760748

### 21757 (6" Kit w/ Vertex Coil overs & V2 Rr Shocks):

217BOX1A  
217BOX11  
21730BOX5  
21730BOX6  
680017L  
680017R  
760748

### 22931 (6" Kit w/ N3 Rr Shocks):

217BOX1A  
217BOX11  
217BOX3  
217BOX8  
21730BOX5  
21730BOX6  
23158

### 22932 (6" Kit w/ N3 Struts & N3 Rr Shocks):

217BOX1A  
217BOX11  
217BOX3  
21730BOX5  
21730BOX6  
649067 x 2  
23158

### 22950 (6" Kit w/ Fr & RR Vertex Shocks):

217BOX1A  
217BOX11  
217BOX3  
21730BOX5  
21730BOX6  
680029L  
680029R  
690001 x 2

### 22970 (6" Kit w/ V2 Rr Shocks):

217BOX1A  
217BOX11  
217BOX3  
217BOX8  
21730BOX5  
21730BOX6  
760748

### 22971 (6" Kit w/ N3 Struts & V2 Rr Shocks):

217BOX1A  
217BOX11  
217BOX3  
21730BOX5  
21730BOX6  
649067 x 2  
760748

### 22957 (6" Kit w/ Vertex Coil overs & V2 Rr Shocks):

217BOX1A  
217BOX11  
217BOX3  
21730BOX5  
21730BOX6  
680029L  
680029R  
760748

### 29900 (6" Kit):

217BOX1A  
217BOX11  
217BOX3  
217BOX9  
21730BOX5  
21730BOX6

### 27532 (4" AT4/Trailboss w/ N3 Struts & N3 Rr Shocks):

217BOX1A  
217BOX11  
217BOX3  
21730BOX5  
21730BOX6  
649067 x 2  
23158

### 27571 (4" AT4/Trailboss w/ N3 Struts & V2 Rr Shocks):

217BOX1A  
217BOX11  
217BOX3  
21730BOX5  
21730BOX6  
649067 x 2  
760739

### 27557 (4" AT4/Trailboss w/ Vertex Coil overs & V2 Rr Shocks):

217BOX1A  
217BOX11  
217BOX3  
21730BOX5  
21730BOX6  
680017L  
680017R  
760739



## 27531,27532, 27571, & 27557 Kit Box & Bag Contents

**▲ NOTICE** Fits crew cab short bed models only. Will not fit models with adaptive ride control.

### Box Kit

#### 217BOX1A

Dr Diff Drop Bracket-1  
Pass Diff Drop Bracket-1  
Rear Diff Mount-1  
Dr Sway Bar Drop Bracket-1  
Pass Sway Bar Drop Bracket-1  
Tie Rod Ends-2  
U-Bolts-4  
Rear Blocks-2  
Lower Skid Plate-1  
217INSTRBAG  
217BAG1  
217BAG2  
9/16BAG  
1263BAG2  
1253BAG2  
21730BAG5

#### 217BOX11

Front Crossmember-1  
Rear Crossmember-1

#### 217BOX3

Front Full Skid Plate-1

#### 217BOX4

Upper Strut Spacers-2  
RC Logo Strut Covers-2  
10MMSTUDBAG-1  
217BAG4

#### 21730BOX5

Driver Knuckle-1

#### 21730BOX6

Passenger Knuckle-1

#### 20158-Rear N3 Shock

#### 649067-N3 Strut

#### 760748-Rear V2 Shock

#### 680017L-Vertex Coilover

#### 680017R-Vertex Coilover

#### 690001-Rear Vertex Shock

### Kit Bags

#### 217INSTRBAG

Instruction Sheet-1  
Warning to Driver Sticker-1

#### 217BAG1-Rear Brake Line Bracket Bag

5/16" x 1" Bolts-5  
5/16" Flat Washers-5  
5/16" Flange Lock Nuts-5  
Rr Dr Brake Line Bracket-1  
Rr Axle Brake Line Bracket-3

#### 217BAG2-Front Kit Bag

##### ***For Sway Bar Drop Brackets:***

10mm x 35mm Bolts-4  
10mm Nylock Nuts-4  
3/8" Flat Washers-8

##### ***For Differential Drop Brackets:***

14mm x 10mm Bolt-1  
9/16" Flat Washers-4  
14mm Nylock Nuts-2  
14mm x 110mm Bolt-1  
1/2" x 1.25" Bolts-2  
1/2" Flat Washers-4  
1/2" Nylock Nuts-2

##### ***For Skid Plates:***

3/8" Flat Washers-12  
3/8" x 1" Bolts-8  
3/8" Lock Washers-8  
3/8" x 3.75" Bolts-2  
3/8" Nylock Nuts-2

##### ***For Front Differential:***

3/16" Vent Hose-1  
3/16" Vent Tube Connector-1

#### 217BAG4-AT4/Trailboss Lower Strut Spacer Bag

AT4/Trailboss Lower Strut Spacers-4  
3/8" Flat Washers-8  
10mm Nylock Nuts-4  
10mm x 80mm Bolts-4

#### 21730BAG5-Cam Bolt Bag

Cam Bolts-4  
18mm Nuts-8

### Kit Bags

#### 1253BAG2-Crossmember Bag

18mm x 140mm Bolts-2  
18mm x 120mm Bolts-2  
Flat Washers-8  
18mm Nylock Nuts-4

#### 10MMSTUDBAG-2-Upper Strut Spacer Bag

10mm Stud-6  
10mm Flange Lock Nut-6  
10mm Nut-1  
1/2" Jam Nut-1

#### 9/16BAG-U-bolt Bag

9/16" Washers-8  
9/16" Nuts-8

#### 1263BAG2-Anti Wrap U-bolt Bag

7/16" x 3 1/8" x 3 1/4" Square U-bolt-4  
7/16" Washer-8  
7/16 Nylock-8

#### 217BAG6- (2020 Models) Frt Brake Line Bracket Bag

1/4" x 3/4" Bolts-2  
1/4" Nylock Nuts-2  
Frt Dr Brake Line Relo Bracket-1  
Frt Pass Brake Line Relo Bracket-3



## 21731, 21732, 21750, 21770, 21771, & 21757 Kit Box & Bag Contents

**▲ NOTICE** Fits crew cab short bed models only. Will not fit models with adaptive ride control.

### Box Kit

#### 217BOX1A

Dr Diff Drop Bracket-1  
Pass Diff Drop Bracket-1  
Rear Diff Mount-1  
Dr Sway Bar Drop Bracket-1  
Pass Sway Bar Drop Bracket-1  
Tie Rod Ends-2  
CV Spacers-2  
U-Bolts-4  
Rear Blocks-2  
Lower Skid Plate-1  
217INSTRBAG2  
217BAG1  
217BAG2  
217BAG6 (2020 Models Only)  
9/16BAG  
1263BAG2  
1253BAG2  
21730BAG5

#### 217BOX11

Front Crossmember-1  
Rear Crossmember-1

#### 217BOX3

Front Full Skid Plate-1

#### 10900BOX2

Dr Upper Strut Spacer-1  
Pass Upper Strut Spacer-1  
RC Logo Strut Covers-2  
10MMSTUDBAG-1  
1307BAG1-1  
Lower Strut Spacers-2  
92130700C INST-1

#### 21730BOX5

Driver Knuckle-1

#### 21730BOX6

Passenger Knuckle-1

20158-Rear N3 Shock

649067-N3 Strut

760748-Rear V2 Shock

680017L-Vertex Coilover

680017R-Vertex Coilover

690001-Rear Vertex Shock

### Kit Bags

#### 217INSTRBAG

Instruction Sheet-1  
Warning to Driver Sticker-1

#### 217BAG1-Rear Brake Line Bracket Bag

5/16" x 1" Bolts-5  
5/16" Flat Washers-5  
5/16" Flange Lock Nuts-5  
Rr Dr Brake Line Bracket-1  
Rr Axle Brake Line Bracket-3

#### 217BAG2-Front Kit Bag

##### ***For Sway Bar Drop Brackets:***

10mm x 35mm Bolts-4  
10mm Nylock Nuts-4  
3/8" Flat Washers-8

##### ***For Differential Drop Brackets:***

14mm x 10mm Bolt-1  
9/16" Flat Washers-4  
14mm Nylock Nuts-2  
14mm x 110mm Bolt-1  
1/2" x 1.25" Bolts-2  
1/2" Flat Washers-4  
1/2" Nylock Nuts-2

##### ***For Skid Plates:***

3/8" Flat Washers-12  
3/8" x 1" Bolts-8  
3/8" Lock Washers-8  
3/8" x 3.75" Bolts-2  
3/8" Nylock Nuts-2  
***For Front Differential:***  
3/16" Vent Hose-1  
3/16" Vent Tube Connector-1

#### 217BAG4-AT4/Trailboss Lower Strut Spacer Bag

AT4/Trailboss Lower Strut Spacers-4  
3/8" Flat Washers-8  
10mm Nylock Nuts-4  
10mm x 80mm Bolts-4

#### 275BAG3-Chevy/GMC Lower Strut Hardware Bag

3/8" Flat Washers-8  
10mm Nylock Nuts-4  
10mm x 65mm Bolts-4

#### 21730BAG5-Cam Bolt Bag

Cam Bolts-4  
18mm Nuts-8

### Kit Bags

#### 1253BAG2-Crossmember Bag

18mm x 140mm Bolts-2  
18mm x 120mm Bolts-2  
Flat Washers-8  
18mm Nylock Nuts-4

#### 10MMSTUDBAG-2-Upper Strut Spacer Bag

10mm Stud-6  
10mm Flange Lock Nut-6  
10mm Nut-1  
1/2" Jam Nut-1

#### 9/16BAG-U-bolt Bag

9/16" Washers-8  
9/16" Nuts-8

#### 1263BAG2-Anti Wrap U-bolt Bag

7/16" x 3 1/8" x 3 1/4" Square U-bolt-4  
7/16" Washer-8  
7/16 Nylock-8

#### 217BAG6- (2020 Models) Frt Brake Line Bracket Bag

1/4" x 3/4" Bolts-2  
1/4" Nylock Nuts-2  
Frt Dr Brake Line Relo Bracket-1  
Frt Pass Brake Line Relo Bracket-3



## 22931, 22932, 22950, 22970, 22971, & 22957 Kit Box & Bag Contents

**▲ NOTICE** Fits GMC crew cab short bed models only. Will not fit models with adaptive ride control and will not fit GMC AT4 or Chevy Trail Boss models.

### Box Kit

#### 217BOX1A

Dr Diff Drop Bracket-1  
Pass Diff Drop Bracket-1  
Rear Diff Mount-1  
Dr Sway Bar Drop Bracket-1  
Pass Sway Bar Drop Bracket-1  
Tie Rod Ends-2  
CV Spacers-2  
U-Bolts-4  
Rear Blocks-2  
Lower Skid Plates-1  
217INSTRBAG2  
217BAG1  
217BAG2  
217BAG6 (2020 Models Only)  
9/16BAG  
1263BAG2  
1253BAG2  
21730BAG5

#### 217BOX11

Front Crossmember-1  
Rear Crossmember-1

#### 217BOX3

Front Full Skid Plate-1

#### 217BOX8

Dr Upper Strut Spacer-1  
Pass Upper Strut Spacer-1  
RC Logo Strut Covers-2  
10MMSTUDBAG-1  
275BAG3  
Preload Spacers-2

#### 21730BOX5

Driver Knuckle-1

#### 21730BOX6

Passenger Knuckle-1

#### 20158-Rear N3 Shock

#### 649067-N3 Strut

#### 760748-Rear V2 Shock

#### 680029L-Vertex Coilover

#### 680029R-Vertex Coilover

#### 690001-Rear Vertex Shock

### Kit Bags

#### 217INSTRBAG

Instruction Sheet-1  
Warning to Driver Sticker-1

#### 217BAG1-Rear Brake Line Bracket Bag

5/16" x 1" Bolts-5  
5/16" Flat Washers-5  
5/16" Flange Lock Nuts-5  
Rr Dr Brake Line Bracket-1  
Rr Axle Brake Line Bracket-3

#### 217BAG2-Front Kit Bag

##### **For Sway Bar Drop Brackets:**

10mm x 35mm Bolts-4  
10mm Nylock Nuts-4  
3/8" Flat Washers-8

##### **For Differential Drop Brackets:**

14mm x 10mm Bolt-1  
9/16" Flat Washers-4  
14mm Nylock Nuts-2  
14mm x 110mm Bolt-1  
1/2" x 1.25" Bolts-2  
1/2" Flat Washers-4  
1/2" Nylock Nuts-2

##### **For Skid Plates:**

3/8" Flat Washers-12  
3/8" x 1" Bolts-8  
3/8" Lock Washers-8  
3/8" x 3.75" Bolts-2  
3/8" Nylock Nuts-2

##### **For Front Differential:**

3/16" Vent Hose-1  
3/16" Vent Tube Connector-1

#### 275BAG3-Chevy/GMC Lower Strut

##### Hardware Bag

3/8" Flat Washers-8  
10mm Nylock Nuts-4  
10mm x 65mm Bolts-4

#### 21730BAG5-Cam Bolt Bag

Cam Bolts-4  
18mm Nuts-8

### Kit Bags

#### 1253BAG2-Crossmember Bag

18mm x 140mm Bolts-2  
18mm x 120mm Bolts-2  
Flat Washers-8  
18mm Nylock Nuts-4

#### 10MMSTUDBAG-2-Upper Strut Spacer Bag

10mm Stud-6  
10mm Flange Lock Nut-6  
10mm Nut-1  
1/2" Jam Nut-1

#### 9/16BAG-U-bolt Bag

9/16" Washers-8  
9/16" Nuts-8

#### 1263BAG2-Anti Wrap U-bolt Bag

7/16" x 3 1/8" x 3 1/4" Square U-bolt-4  
7/16" Washer-8  
7/16 Nylock-8

#### 217BAG6- (2020 Models) Frt Brake Line Bracket Bag

1/4" x 3/4" Bolts-2  
1/4" Nylock Nuts-2  
Frt Dr Brake Line Relo Bracket-1  
Frt Pass Brake Line Relo Bracket-3



## 29900 Kit Box & Bag Contents

**▲ NOTICE** Fits crew cab short bed models with Adaptive Ride Control only. Will not fit GMC AT4 or Chevy Trail Boss models.

### Box Kit

#### 217BOX1A

Dr Diff Drop Bracket-1  
Pass Diff Drop Bracket-1  
Rear Diff Mount-1  
Dr Sway Bar Drop Bracket-1  
Pass Sway Bar Drop Bracket-1  
Tie Rod Ends-2  
CV Spacers-2  
U-Bolts-4  
Rear Blocks-2  
Lower Skid Plates-1  
217INSTRBAG2  
217BAG1  
217BAG2  
217BAG6 (2020 Models Only)  
9/16BAG  
1263BAG2  
1253BAG2  
21730BAG5

#### 217BOX11

Front Crossmember-1  
Rear Crossmember-1

#### 217BOX3

Front Full Skid Plate-1

#### 217BOX9

Dr Upper Strut Spacer-1  
Pass Upper Strut Spacer-1  
RC Logo Strut Covers-2  
10MMSTUDBAG-1  
217BAG7  
Rear Shock Brackets-2  
Preload Spacers-2

#### 21730BOX5

Driver Knuckle-1

#### 21730BOX6

Passenger Knuckle-1

### Kit Bags

#### 217INSTRBAG

Instruction Sheet-1  
Warning to Driver Sticker-1

#### 217BAG1-Rear Brake Line Bracket Bag

5/16" x 1" Bolts-5  
5/16" Flat Washers-5  
5/16" Flange Lock Nuts-5  
Rr Dr Brake Line Bracket-1  
Rr Axle Brake Line Bracket-3

#### 217BAG2-Front Kit Bag

##### **For Sway Bar Drop Brackets:**

10mm x 35mm Bolts-4  
10mm Nylock Nuts-4  
3/8" Flat Washers-8

##### **For Differential Drop Brackets:**

14mm x 10mm Bolt-1  
9/16" Flat Washers-4  
14mm Nylock Nuts-2  
14mm x 110mm Bolt-1  
1/2" x 1.25" Bolts-2  
1/2" Flat Washers-4  
1/2" Nylock Nuts-2

##### **For Skid Plates:**

3/8" Flat Washers-12  
3/8" x 1" Bolts-8  
3/8" Lock Washers-8  
3/8" x 3.75" Bolts-2  
3/8" Nylock Nuts-2  
**For Front Differential:**  
3/16" Vent Hose-1  
3/16" Vent Tube Connector-1

#### 217BAG7-Adaptive Ride Control Kit Bag

##### **For Lower Strut Spacers:**

3/8" Flat Washers-8  
10mm Nylock Nuts-4  
10mm x 65mm Bolts-4

##### **For Rear Shock Brackets:**

1/2" x 1.5" Bolts-2  
1/2" Nylock Nuts-2  
1/2" Flat Washers-2  
9/16" x 3.5" Bolts-2  
9/16" Nylock Nuts-2  
9/16" Flat Washers-2  
Rr Shock Bracket Washers-2

#### 21730BAG5-Cam Bolt Bag

Cam Bolts-4  
18mm Nuts-8

### Kit Bags

#### 1253BAG2-Crossmember Bag

18mm x 140mm Bolts-2  
18mm x 120mm Bolts-2  
Flat Washers-8  
18mm Nylock Nuts-4

#### 10MMSTUDBAG-2-Upper Strut Spacer Bag

10mm Stud-6  
10mm Flange Lock Nut-6  
10mm Nut-1  
1/2" Jam Nut-1

#### 9/16BAG-U-bolt Bag

9/16" Washers-8  
9/16" Nuts-8

#### 1263BAG2-Anti Wrap U-bolt Bag

7/16" x 3 1/8" x 3 1/4" Square U-bolt-4  
7/16" Washer-8  
7/16 Nylock-8

#### 217BAG6- (2020 Models) Frt Brake Line Bracket Bag

1/4" x 3/4" Bolts-2  
1/4" Nylock Nuts-2  
Frt Dr Brake Line Relo Bracket-1  
Frt Pass Brake Line Relo Bracket-3



21731 Kit Pic



22931 Kit Pic



## FRONT INSTALLATION

1. Park the vehicle on a level surface and chock the rear wheels. Lock the steering wheel in the straight position.
2. Jack up the front of the vehicle. Place jack stands under the frame rails and lower onto jack stands letting the front suspension hang.
3. Raise the hood and disconnect the battery using a 10mm socket.
4. Remove the tires and wheels.
5. Remove the 6 bolts holding the factory skid plates, using a 13mm socket. **See Photos 1 & 2.**

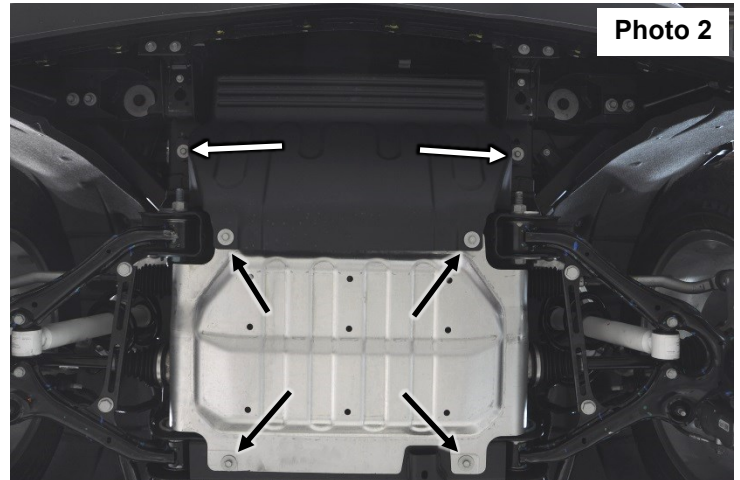

6. Unplug the three connectors going to the rack and pinion. **See Photo 3.**
7. Using a 21mm socket, remove the tie-rod nut as shown in **Photo 4**. Using a hammer, strike the front of the mount to dislodge the tie rod end. Remove from the knuckle.

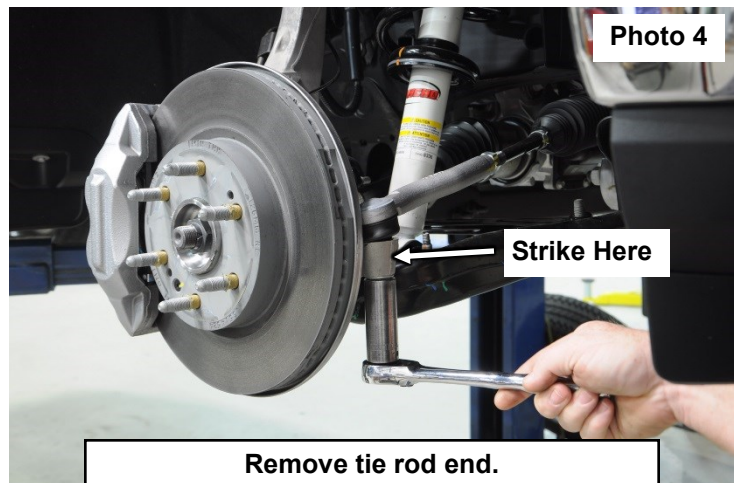
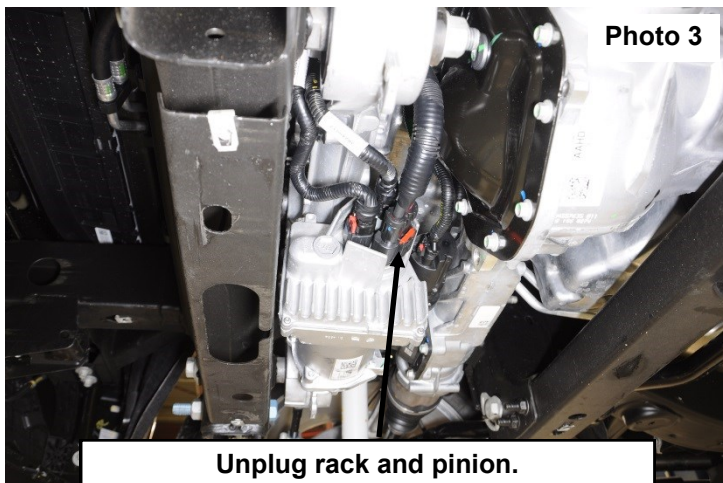



8. Remove the ABS wire from the clip on the upper control arm mount. **See Photo 5.**
9. Using a 10mm socket, remove the brake line and brake pad sensor wires from the knuckle. Retain hardware. **See Photo 6.**

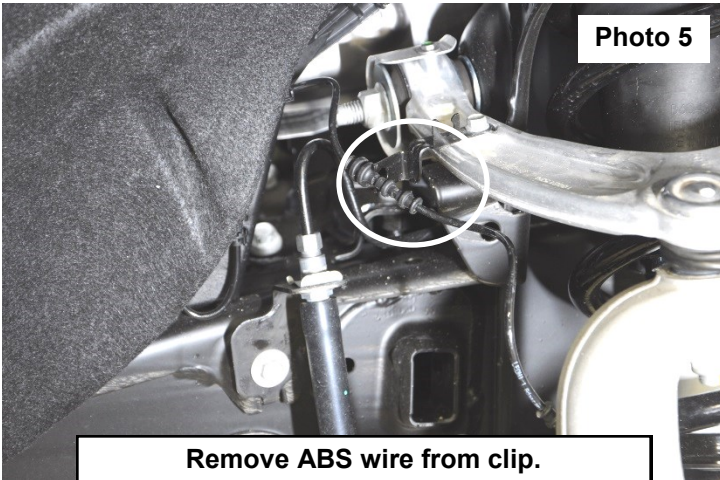

**Remove ABS wire from clip.**

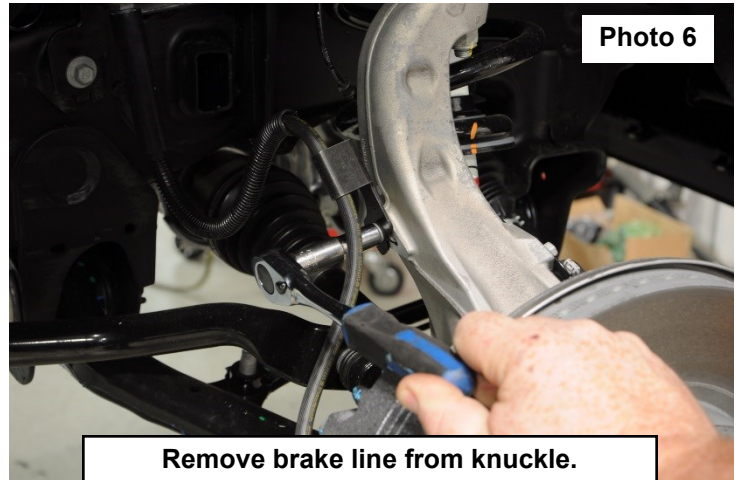

**Remove brake line from knuckle.**

10. Unplug the brake pad sensor wire. **See Photo 7.**
11. Using an 18mm socket, remove the brake caliper. Hang caliper out of the way. **Do not hang the caliper by the brake line.** Retain hardware. **See Photo 8.**

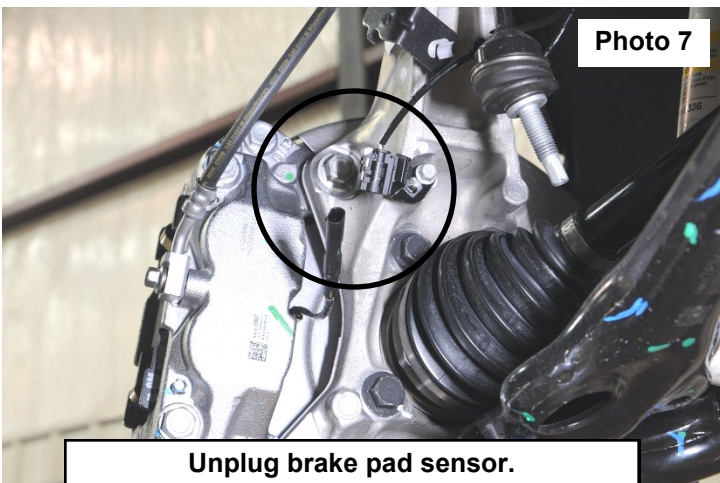

**Unplug brake pad sensor.**

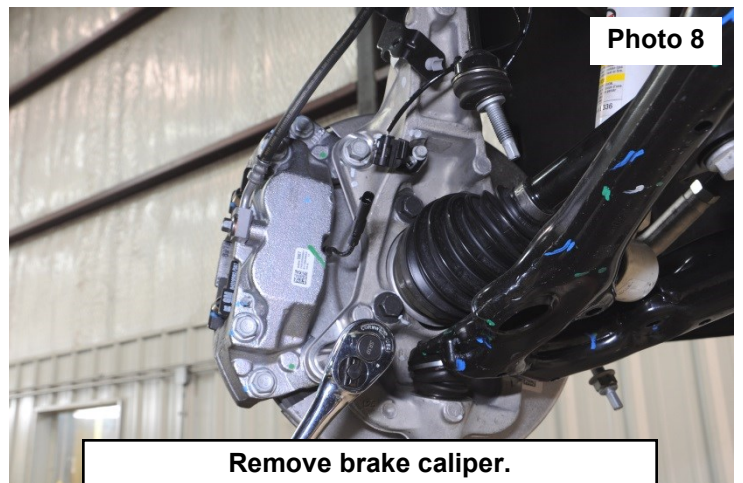

**Remove brake caliper.**

12. Using a 10mm socket, remove the ABS wire bracket from the knuckle. Retain hardware. **See Photo 9.**
13. Using a 10mm socket, remove the ABS sensor from the knuckle. Retain hardware and hang ABS wire out of the way. **See Photo 10.**

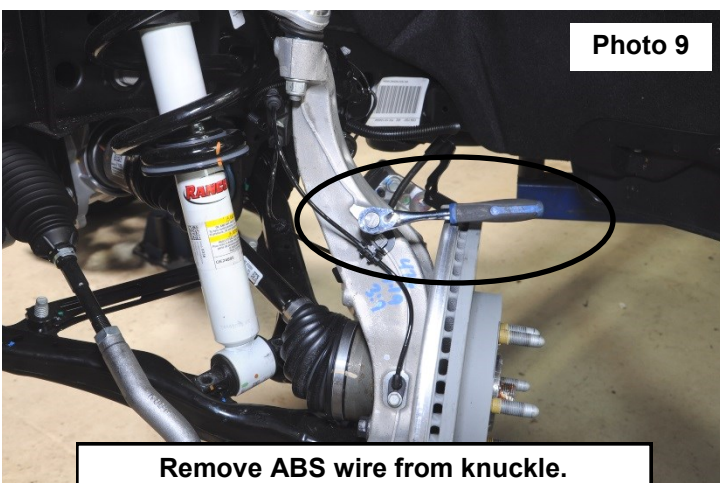

**Remove ABS wire from knuckle.**

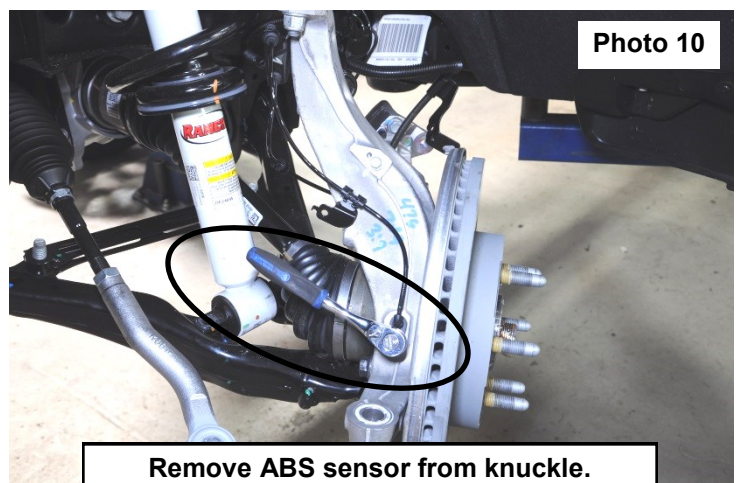

**Remove ABS sensor from knuckle.**

14. **2wd models skip to the next step.** Remove the CV axle nut using a 36mm socket. Retain hardware. **See Photo 11.**
15. Using a 30T torx, remove the brake rotor. Retain hardware. **See Photo 12.**

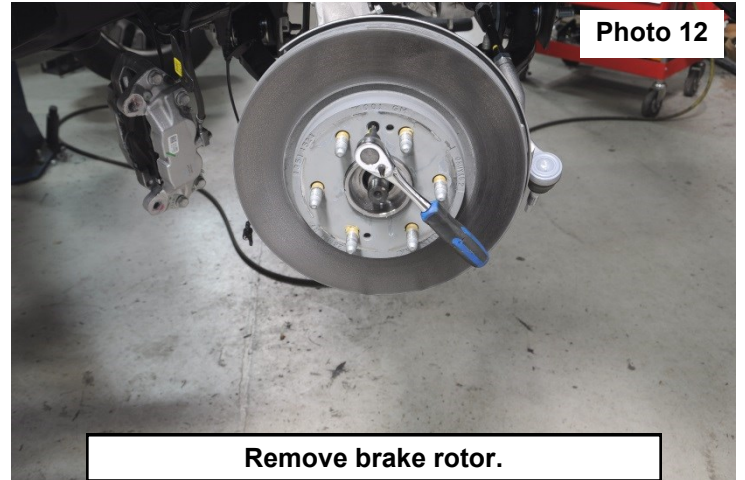
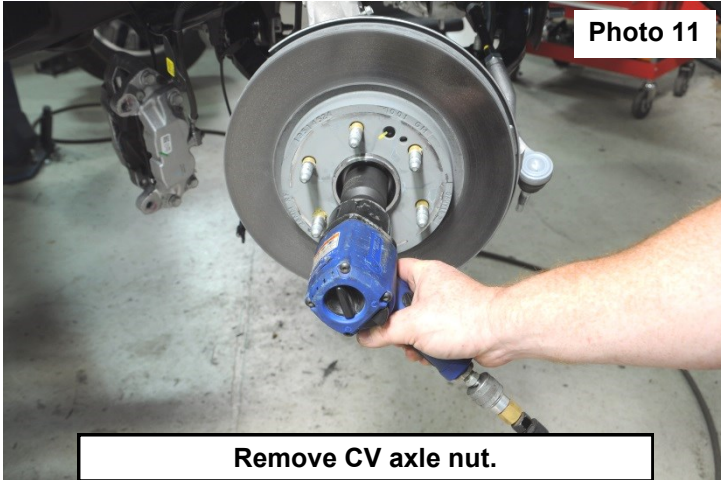

16. Using an 18mm wrench, loosen the upper ball joint nut. Do not completely remove the nut. Strike the knuckle with a hammer to release the ball joint taper. **See Photo 13.**
17. Support the lower control arm.
18. Using a 15mm socket, remove the lower strut mounting bolts. **See Photo 14.**

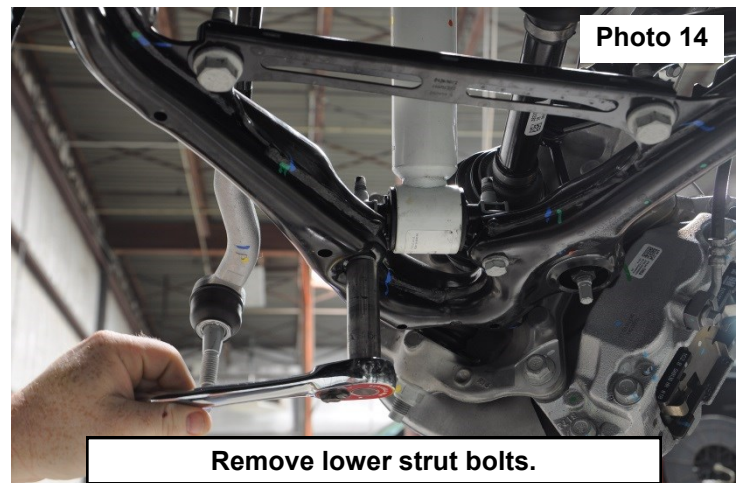
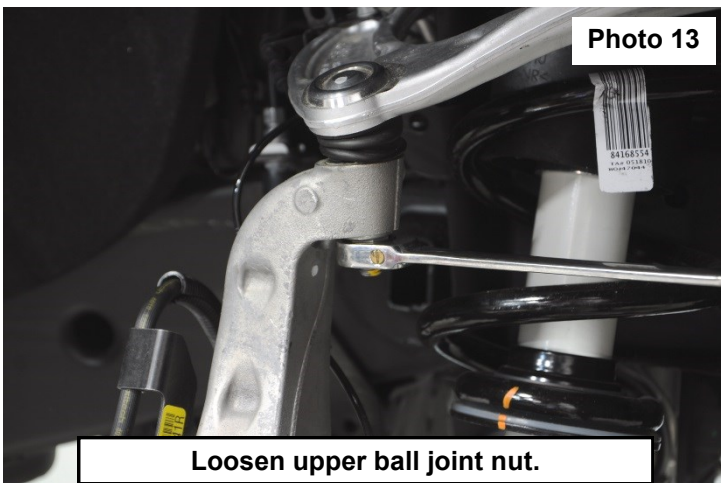

19. Using a 24mm socket, loosen the lower ball joint nut. Do not completely remove the nut. Strike the knuckle with a hammer to release the ball joint taper, remove the upper and lower ball joint nuts and remove the knuckle from the truck. Retain hardware. **See Photo 15.**
20. Remove the lower sway link nut using an 18mm socket. Retain hardware. **See Photo 16.**

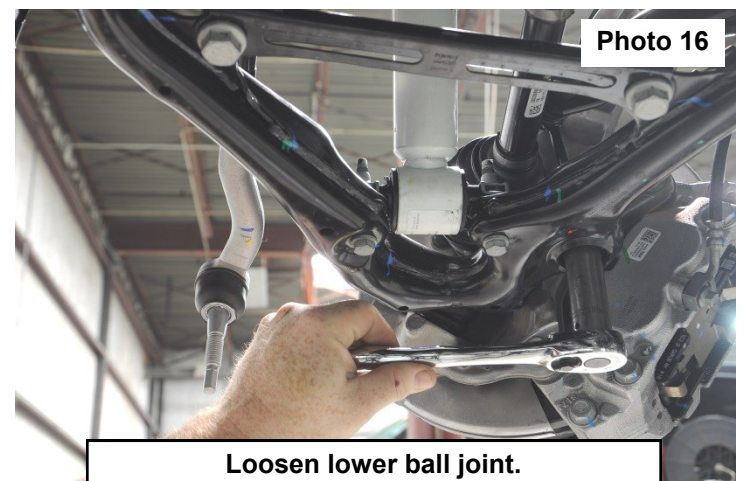
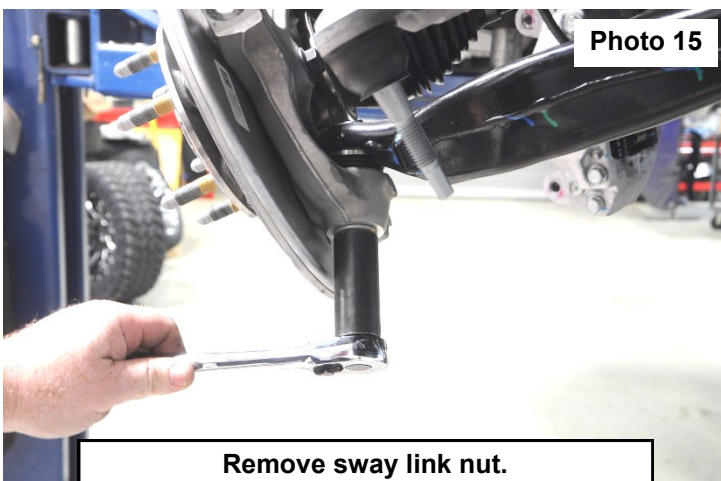

21. On the passenger side, use a 13mm socket to remove the bolt holding the plastic wire loom that is attached to the frame and the upper strut tower. Retain hardware. (Inner fender was removed for pictures) **See Photo 17.**
22. Using an 18mm wrench, remove the upper strut nuts. Retain hardware. **See Photo 18.**

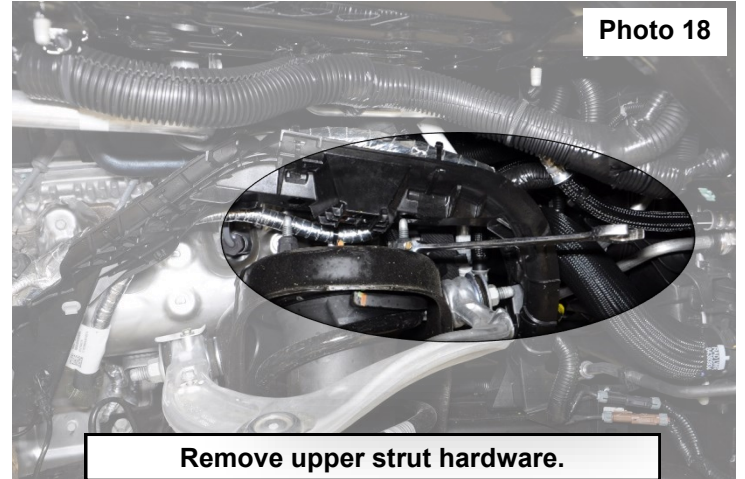
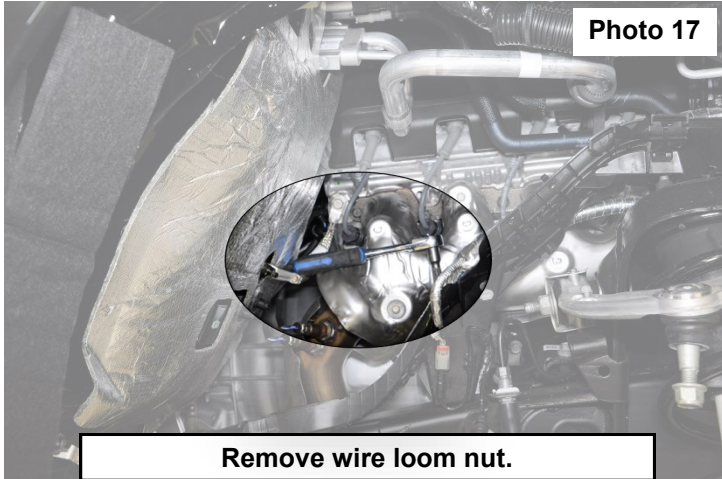

23. Using a 10mm socket, remove the sway bar from the frame. Retain hardware. **See Photo 19.**
24. Using a 27mm socket, remove the lower control arms. Retain hardware. **See Photo 20.**

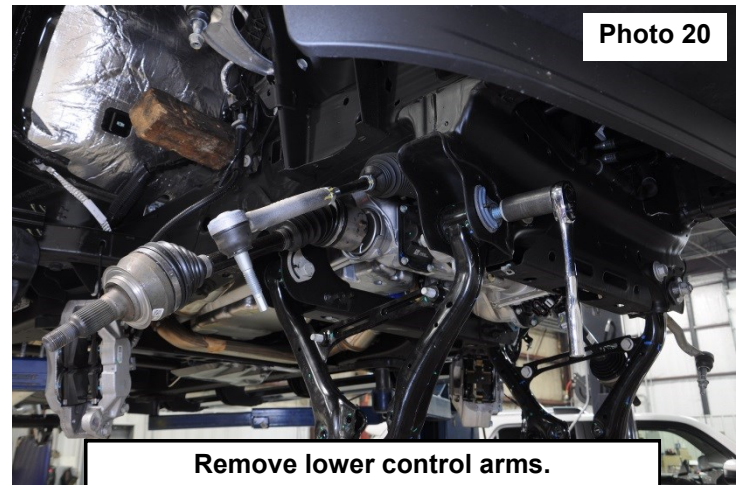

25. **2wd models skid to step 31.** Mark the front driveshaft and the front yoke. **See Photo 21.**
26. Remove the front driveshaft using a 10mm socket. Retain hardware. Do not allow driveshaft to hang from the rear joint, this could damage the boot. Support the driveshaft with a jack stand. **See Photo 22.**

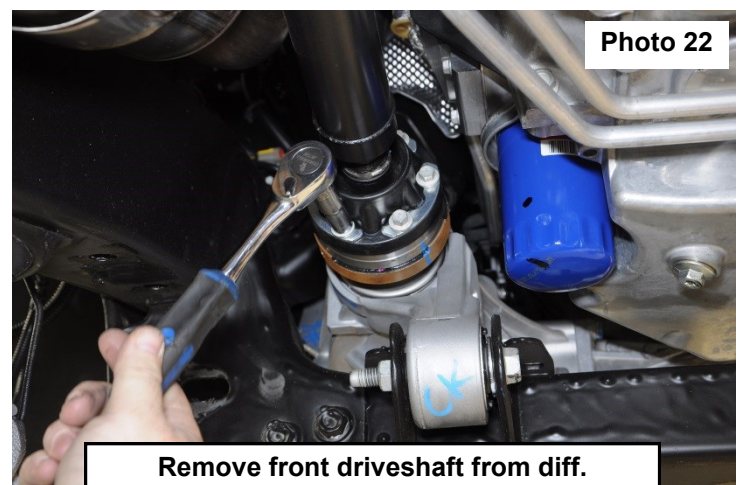

27. Using a 21mm wrench and socket, remove the rear diff bolt from the crossmember. Retain hardware. **See Photo 23.**  
 28. Unplug the diff actuator and remove the wire loom clips from the diff and vent hose. **See Photo 24.**

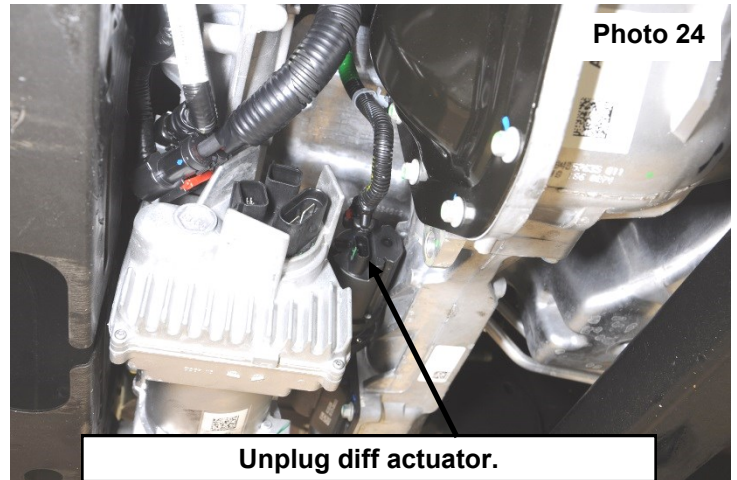
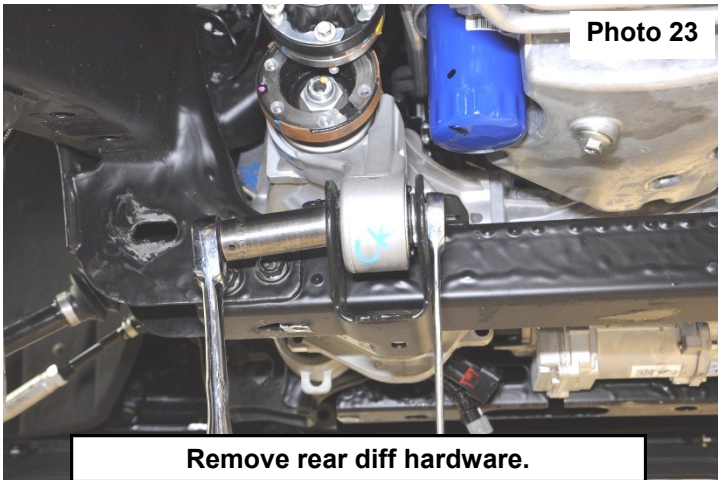

29. Support the differential using a jack.  
 30. Using a 21mm socket and wrench, remove the nut from the passenger side diff bolt. Retain hardware. **See Photo 25.**  
 31. Remove the rear crossmember using an 18mm wrench and socket. **See Photo 26. 2wd / 4wd models must remove the rear crossmember.**

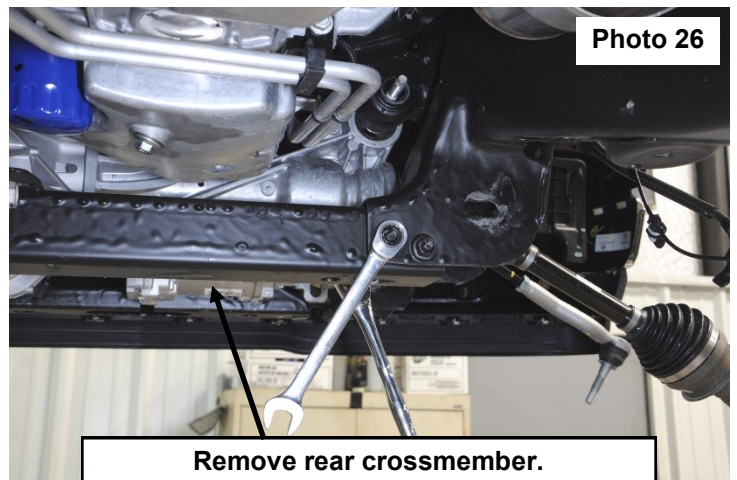
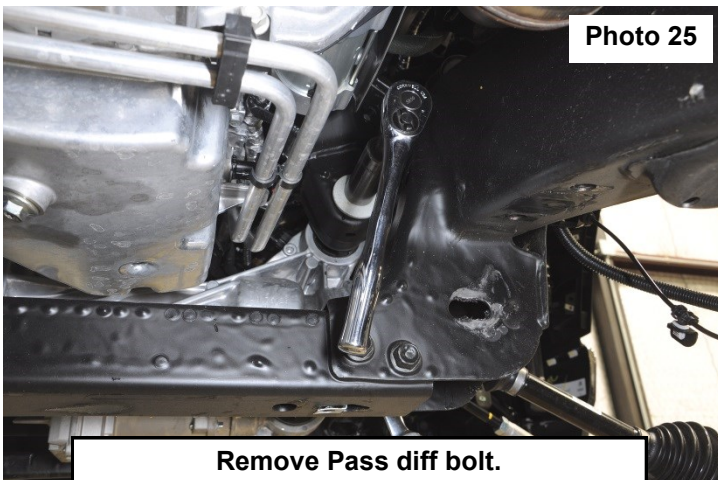

32. **2wd models skip to step 39.** Using a 21mm socket and 22mm wrench, remove the driver and passenger diff bolts. To remove the pass side bolt, you will need to push the diff to the pass side and roll the back of the diff upward. Lower the differential. Retain hardware. **See Photo 27.**  
 33. On the rear driver side crossmember mount, measure 2-3/4" and mark. **See Photo 28.**

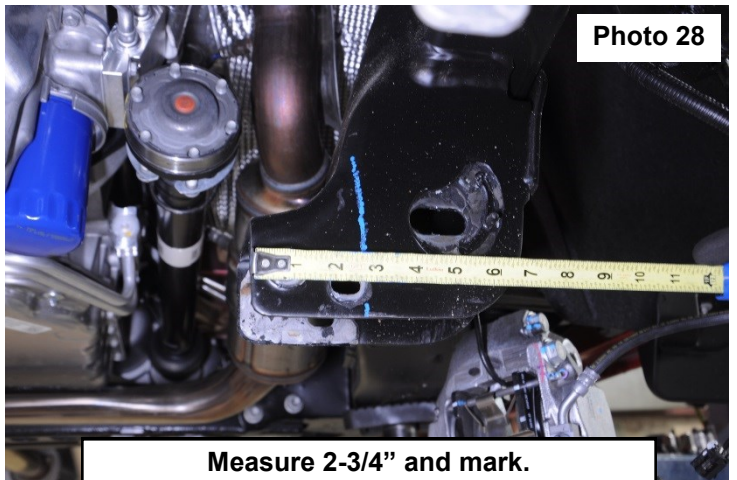
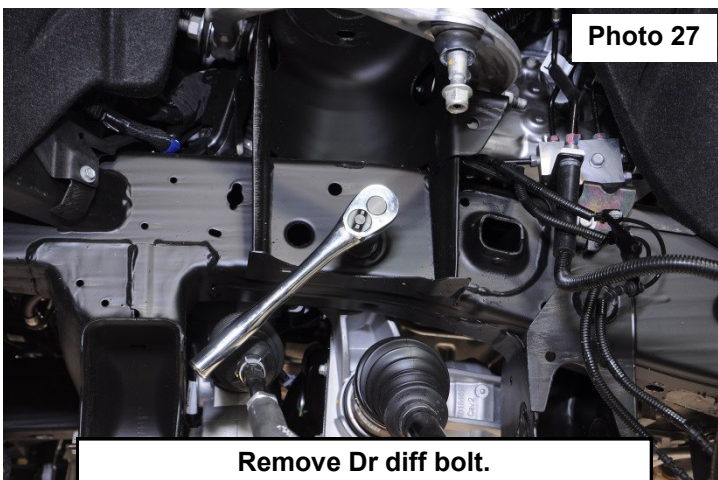

34. Cut along the mark made in step 33 using a reciprocating saw. Sand and paint the cut edge to prevent rust. **See Photo to 29.**
35. Install the supplied driver side diff drop bracket using the factory bolt. Do not tighten at this time. **See Photo 30.**

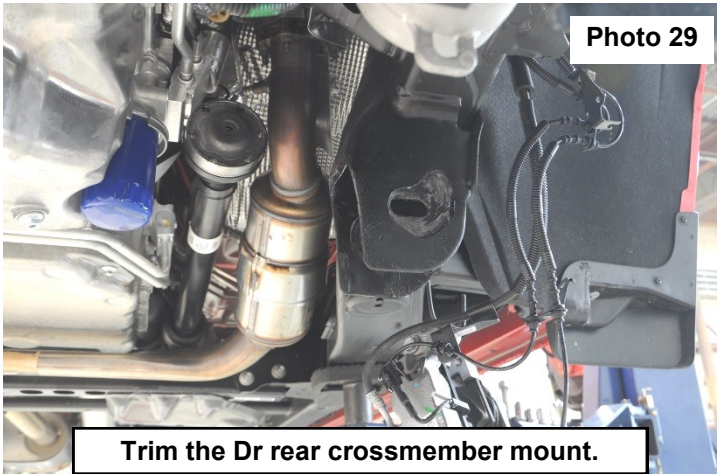

**Trim the Dr rear crossmember mount.**

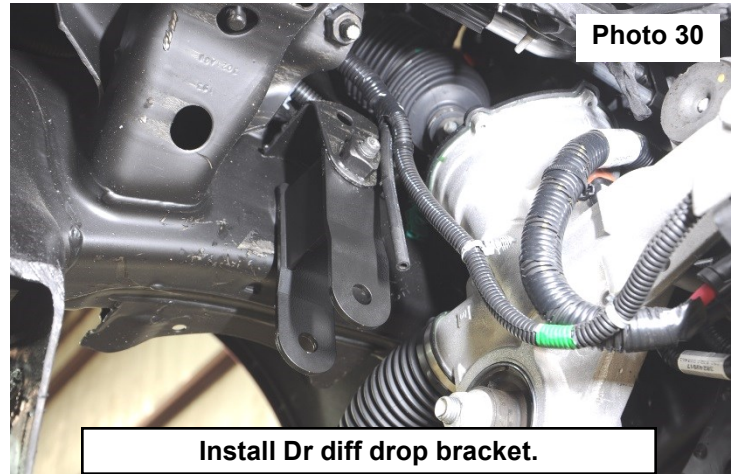

**Install Dr diff drop bracket.**

36. Install the supplied passenger side diff drop using the supplied 14mm x 110mm bolt, washers, and nylock nut (217BAG2). Do not tighten at this time. **See Photo 31.**
37. Install the diff using the factory hardware on the pass side and the supplied 14mm x 100m bolt, washers, and nylock nut (217BAG2) on the driver side. Do not tighten at this time. **See Photos 32 & 33.**

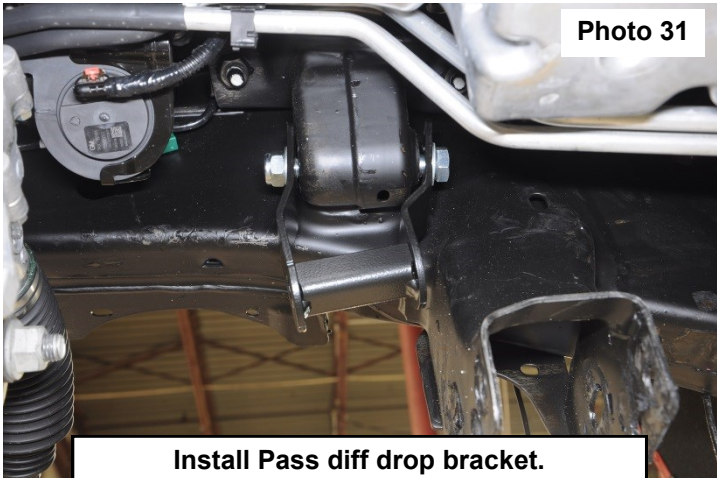

**Install Pass diff drop bracket.**

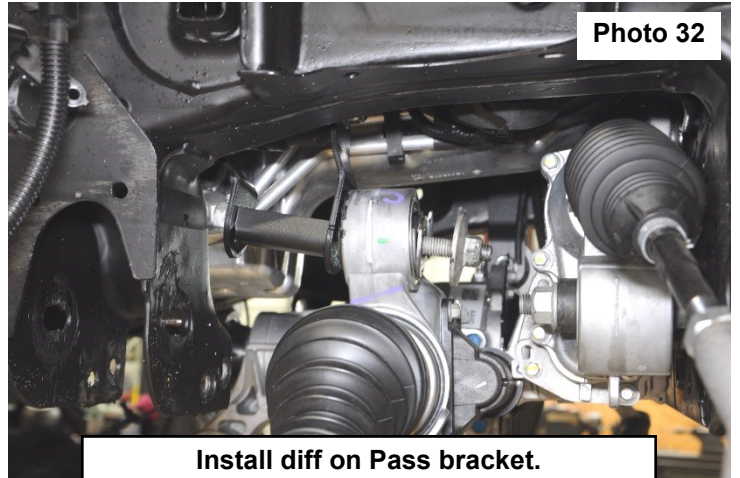

**Install diff on Pass bracket.**

38. Cut the supplied 3/16" vent tube (217BAG2) in half, install the supplied 3/16" vent tube coupler (217BAG2) and one half of the 3/16" vent tube on the diff and in the factory vent tube. **See Photo 34.**

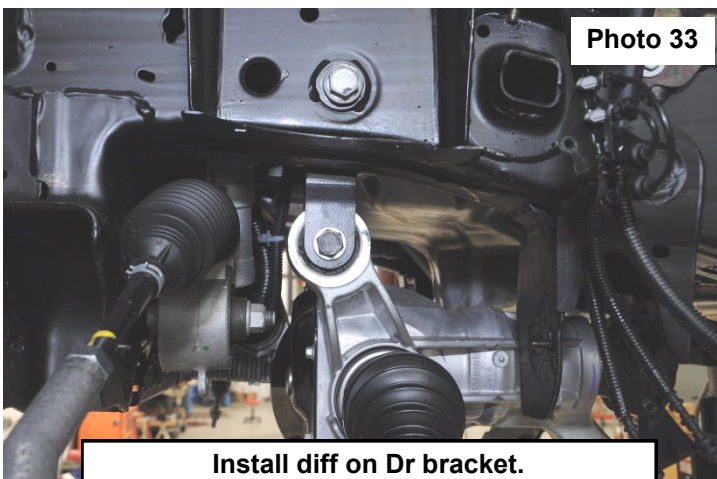

**Install diff on Dr bracket.**

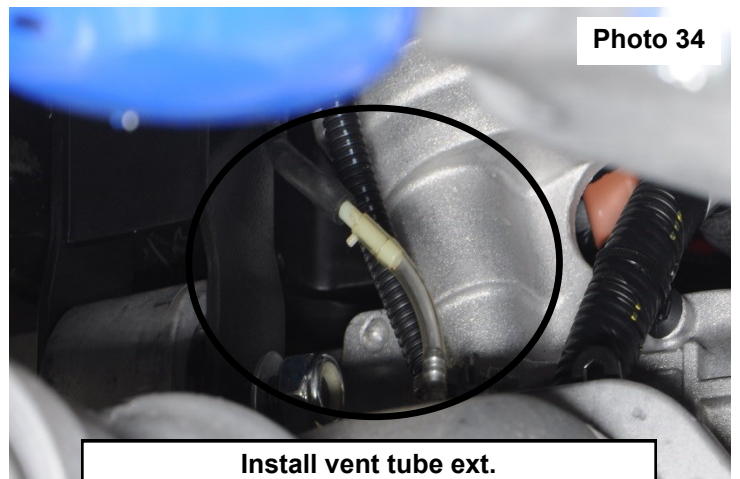

**Install vent tube ext.**

39. Install the supplied sway bar drops using the factory hardware. Do not tighten at this time. **See Photo 35.**
40. Install the supplied rear crossmember using the supplied 18mm x 140mm bolts, washers, and 18mm nylock nuts (1253BAG2). The bolts will go through the sway bar drop brackets. Do not tighten. **See Photo 36.**

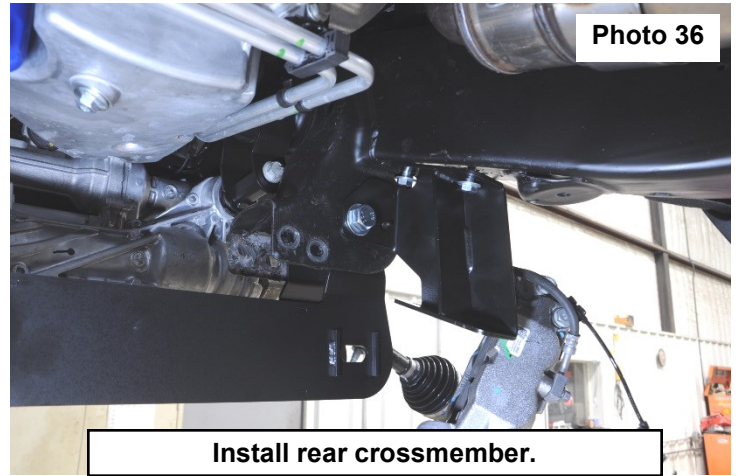

41. Install the supplied rear diff mount onto the rear crossmember using the supplied 1/2" x 1.25" bolts, flat washers, and nylock nuts (217BAG2). Install the factory hardware through the diff and diff mount. Do not tighten at this time. **See Photo 37.**
42. Install the supplied front crossmember using the supplied 18mm x 120mm bolts, flat washers, and nylock nuts (1253BAG2). Do not tighten at this time. **See Photo 38.**

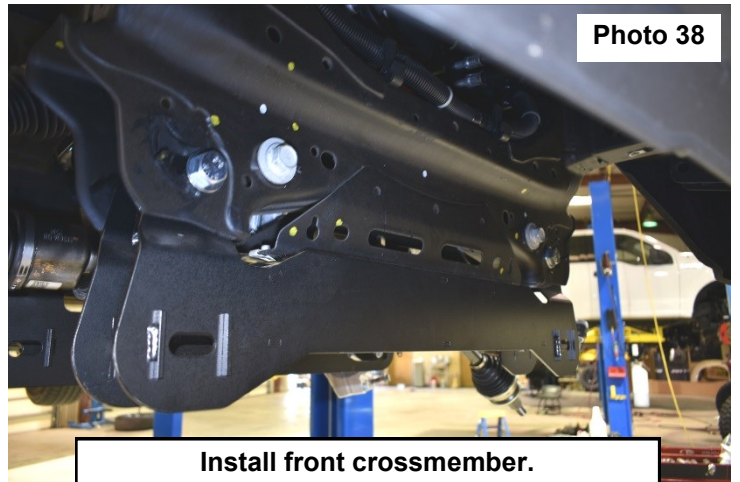
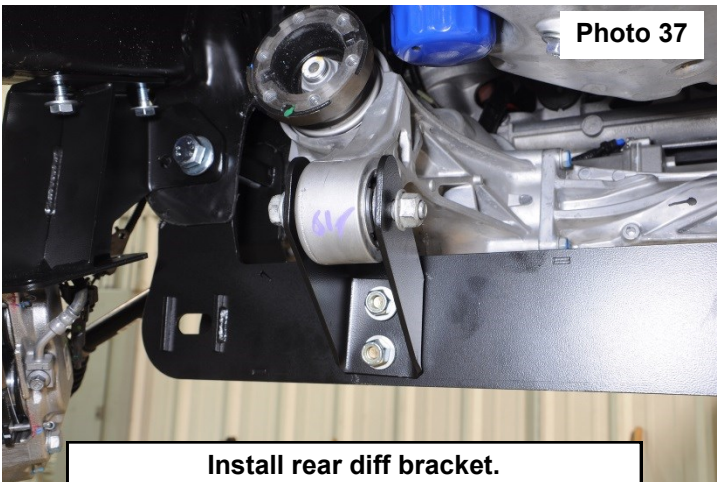

43. Install the lower control arms using the supplied cam bolts and hardware (21730BAG5). Do not tighten at this time. **See Photo 39.**
44. Using a 21mm socket and 22mm wrench, torque the upper driver diff mount bolt to 120ft/lbs. **See Photo 40.**

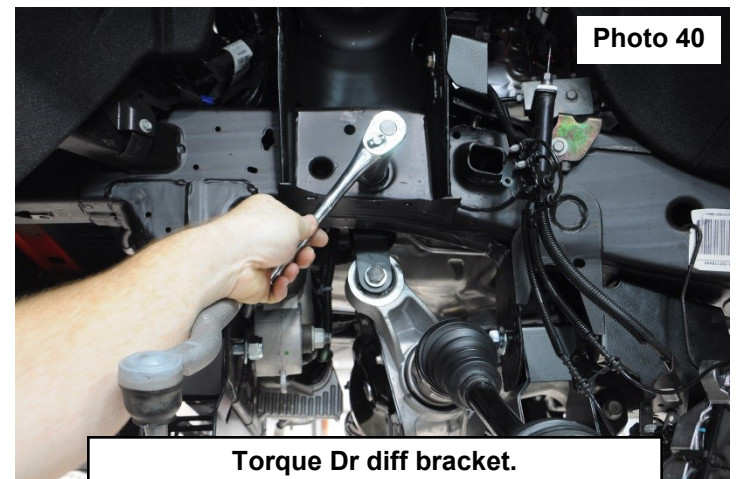
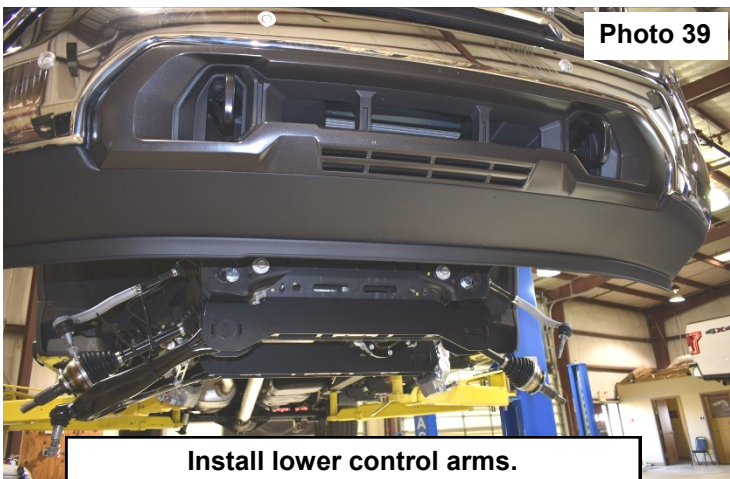

45. Using a 21mm wrench and 22mm socket, torque the dr diff bolt to 85ft/lbs. **See Photo 41.**

46. Using a 21mm wrench and 22mm socket, torque the pass diff drop bolt to 85ft/lbs. **See Photo 42.**

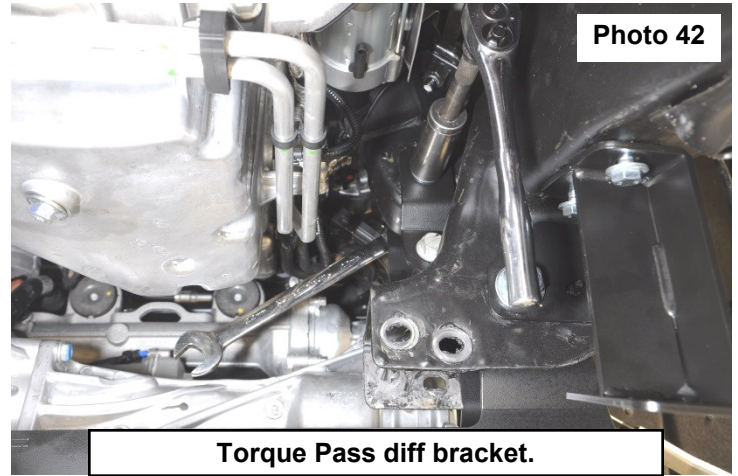
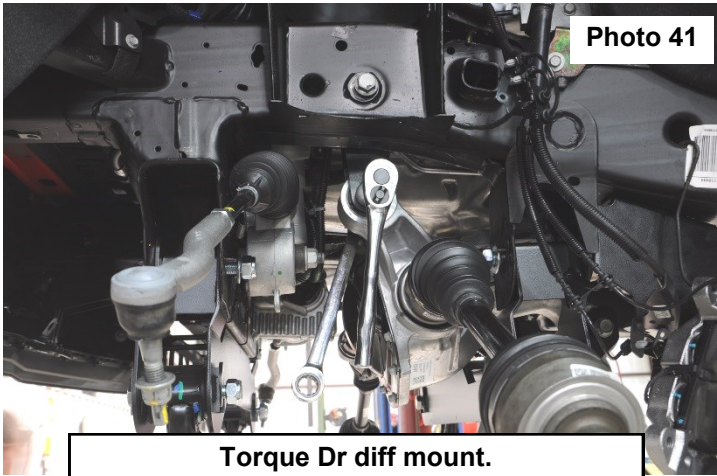

47. Using a 21mm wrench and 22mm socket, torque the pass diff bolt to 85ft/lbs. **See Photo 43.**

48. Using a 3/4" wrench and socket, torque the rear diff bracket hardware to 65ft/lbs. **See Photo 44.**

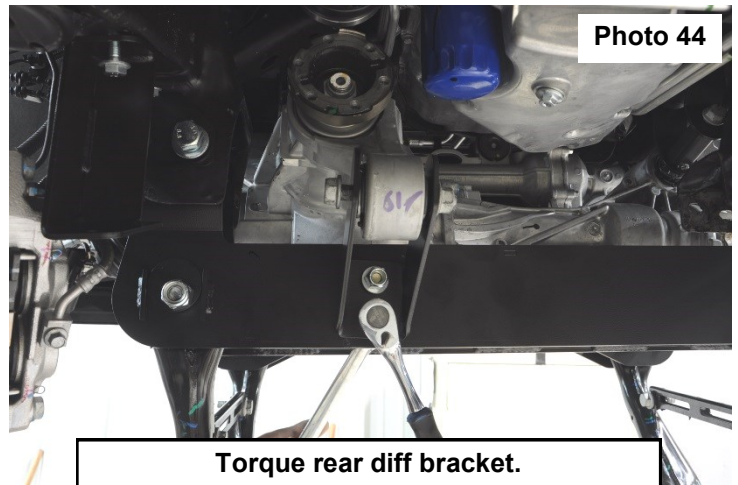
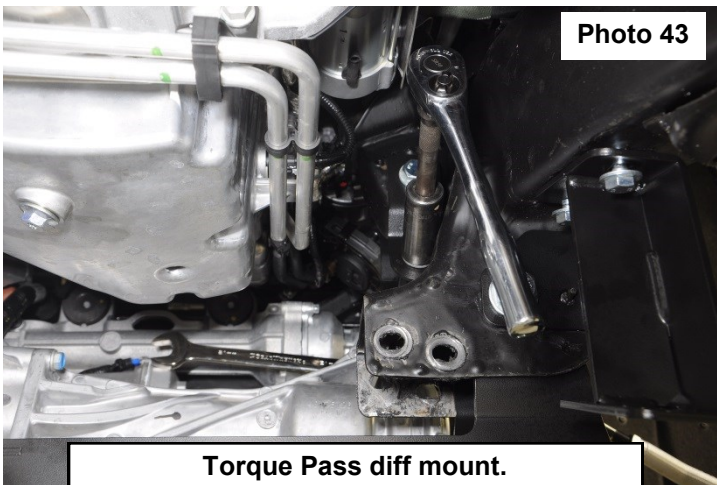

49. Using a 21mm wrench and 22mm socket, torque the rear diff bolt to 126ft/lbs. **See Photo 45.**

50. Using a 27mm wrench and socket, torque the crossmember bolts to 170ft/lbs. **See Photo 46.**

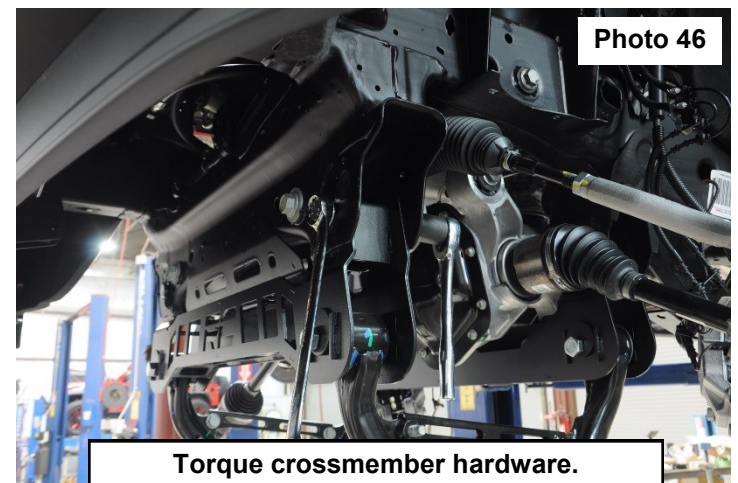
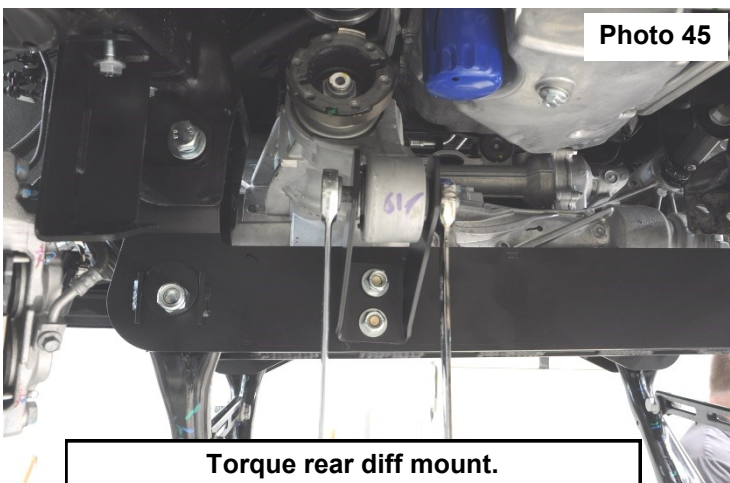

51. Using a 10mm wrench, tighten the sway bar drop hardware. Torque to 35ft/lbs. **See Photo 47.**
52. **2wd models skip to next step.** Install the front drive shaft on the differential using the factory hardware. Torque to factory specs using a 10mm socket. **See Photo 48.**

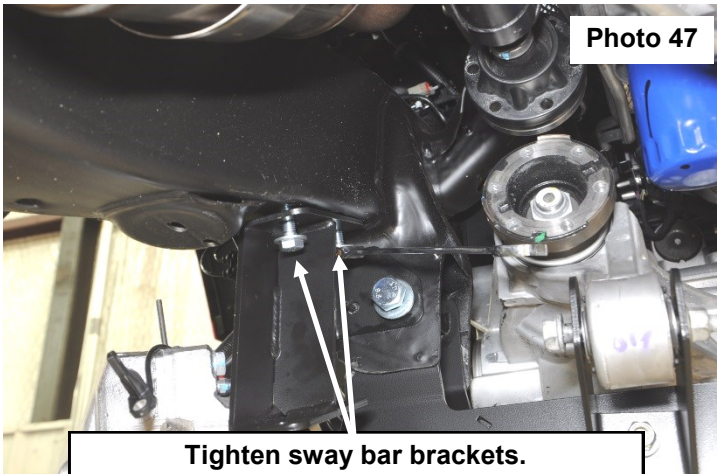

**Tighten sway bar brackets.**

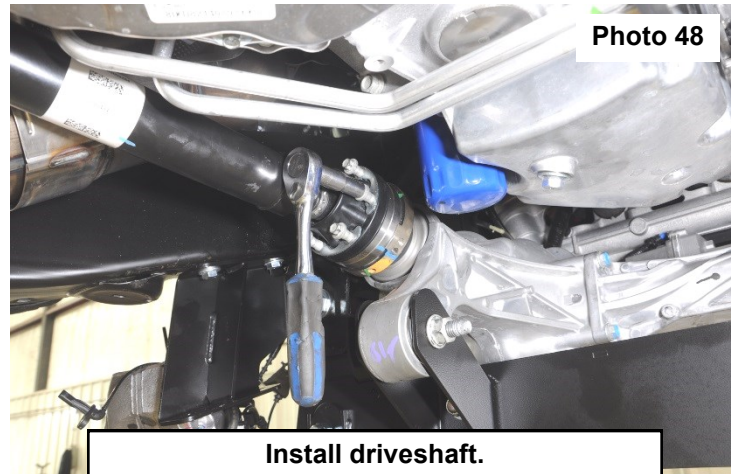

**Install driveshaft.**

53. Install the sway bar on the drop brackets using the supplied 10mm x 35mm bolts, washers, and nylock nuts (217BAG2). Torque to 32ft/lbs using a 17mm wrench and socket. **See Photo 49.**
54. **If installing N3 struts or Vertex coilovers, refer to installation instructions included with those items and skip to step 65.**
55. **Chevy, AT4, & Trailboss skip to step 61.** Place the strut into a strut compressor. Make sure to locate or mark the position of the lower barpin. Compress the spring to remove tension from the strut top plate. Remove the center nut with

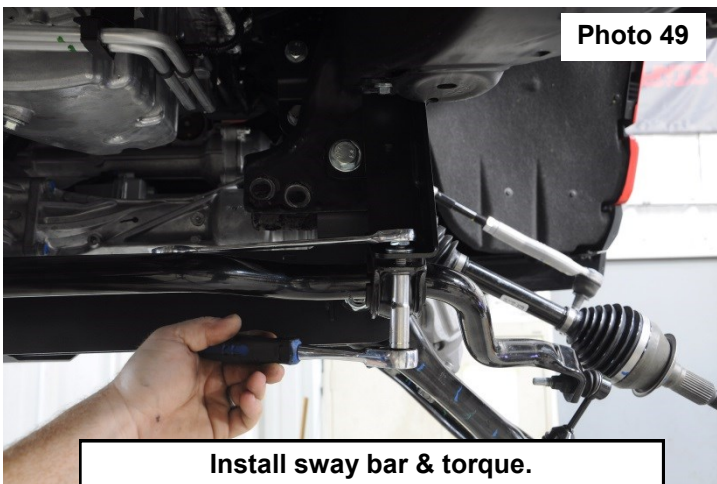

**Install sway bar & torque.**



**Remove the nut from the upper strut.**

- a 15mm socket. Retain factory nut. **See Photo 50.**
56. Remove the strut from the bottom of the assembly as shown in **Photo 51.**



**Remove the strut from the coil spring.**



**Remove the isolator.**

57. Remove the factory lower coil spring isolator from the OEM strut. **See Photo 52.** Save for reuse.



58. Install the strut pre-load spacer onto the strut, **chamfer down**. Then, place the isolator onto the strut. **See Photo 53.**  
 59. Slide the strut up through the bottom of the factory coil spring and hand tighten the factory nut. Make sure the barpin is located in the same position by lining up the marks made on the strut. **See Photo 54.**

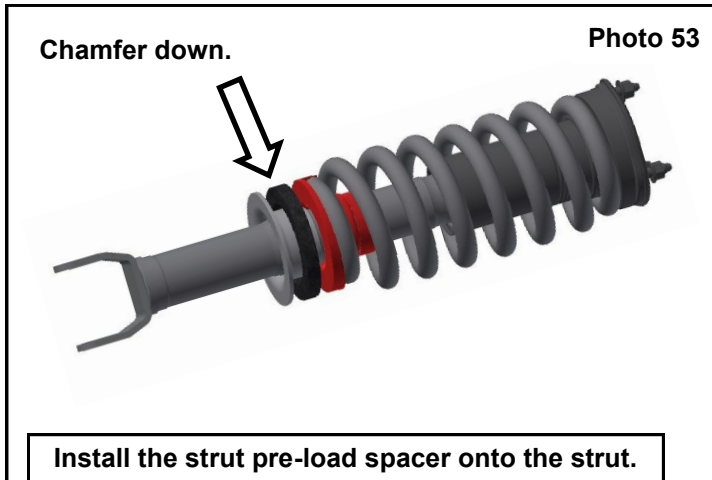

60. Using a 15mm socket tighten the center nut on the strut plate. Torque to 33-35 ft-lbs. **See Photo 55.**  
 61. Install the supplied 10mm studs (10mmstudbag-2) into the strut spacer using the supplied 1/2" jam nut (10mmstudbag-2) between the spacer and the 10mm nut (10mmstudbag-2). Tighten the 10mm nut using a 17mm socket, pulling the stud into the spacer. **Do not using an impact. See Photos 56 & 57.**

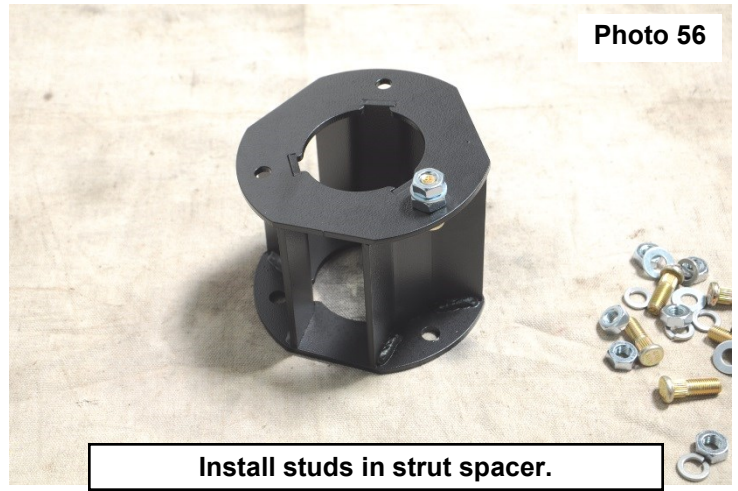

62. Install the strut spacer (**Chevy 6" and GMC models Only: D for driver side and P for passenger side, to the outside of the vehicle**) and the supplied strut cover on the factory strut using the factory hardware. Tighten using an 18mm wrench. **See Photo 58.**

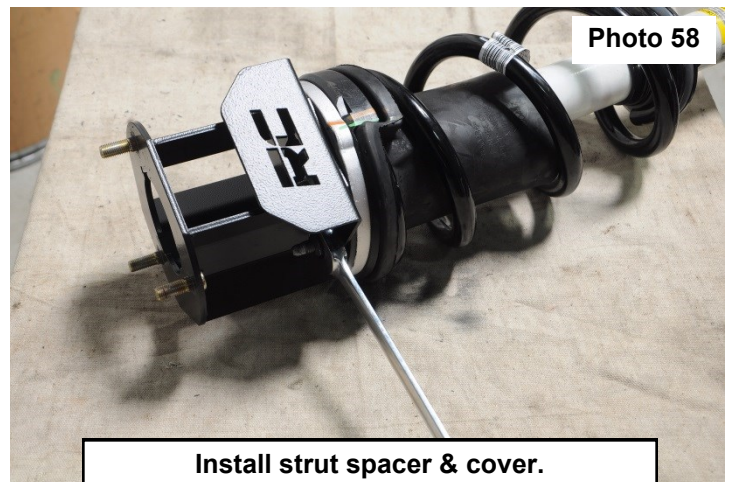

63. Install the strut into the upper mount using the supplied 10mm hardware (10mmstudbag-2). Tighten using a 17mm wrench. **See Photo 59.**
64. **Chevy 6" kits Only:** Refer to 92130700C instructions in 10900BOX2 for lower strut spacer install. **Trailboss and AT4 models will use the shorter spacers and 10mm x 80mm bolts, washers, and nylock nuts (217BAG4)** Torque to 32ft/lbs using a 17mm wrench and socket. **See Photo 60.**
- NOTE: You may have to push the lower control arm down to install the spacers.**
65. Install the plastic wiring loom using the factory hardware, tighten using a 13mm socket.
66. Using an 18mm socket, remove the hub bearing from the factory knuckle. **See Photos 61 & 62.**
67. Carefully remove the hub bearing O-ring from the factory knuckle. **See Photo 63.**

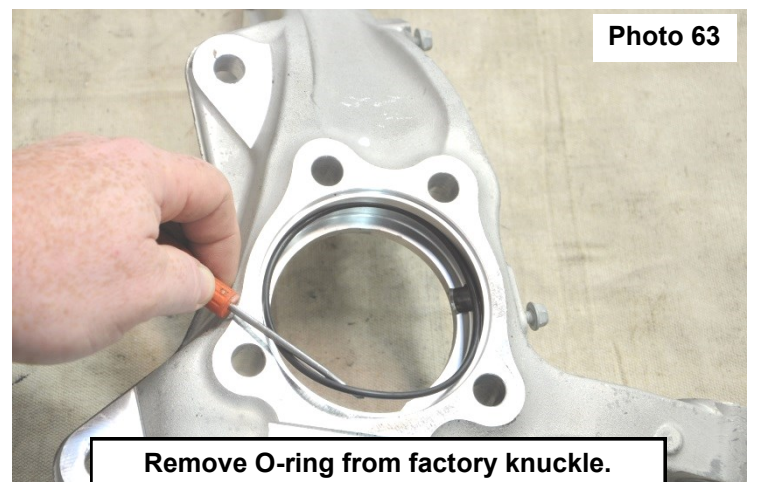
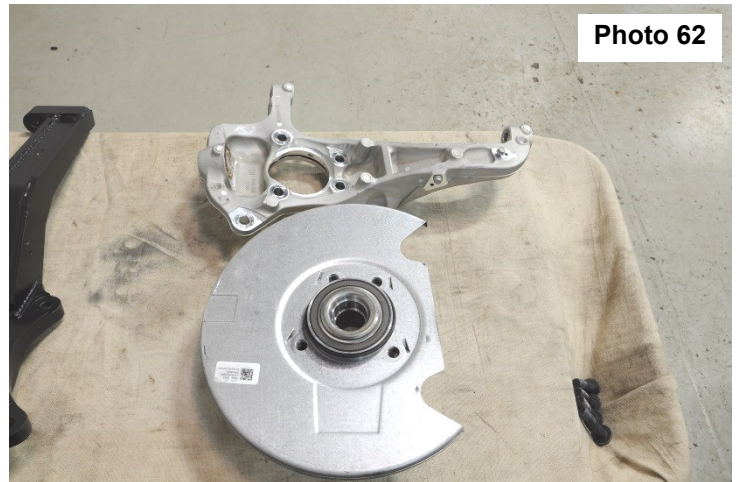
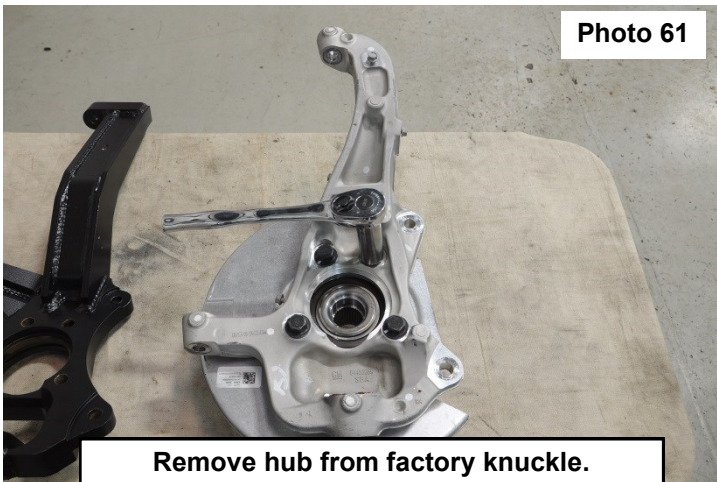
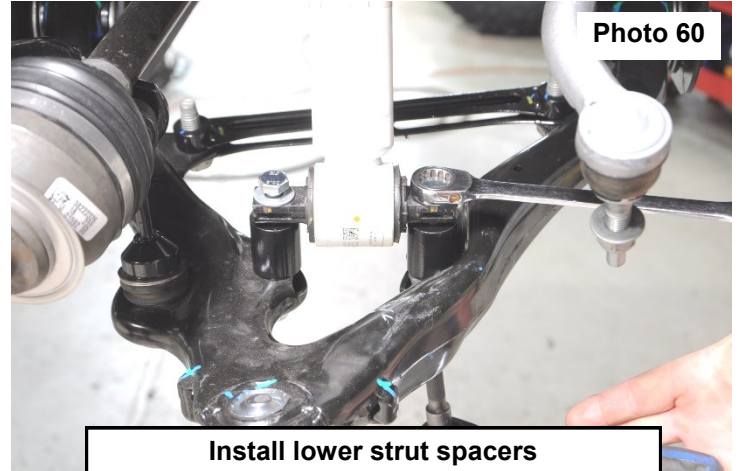
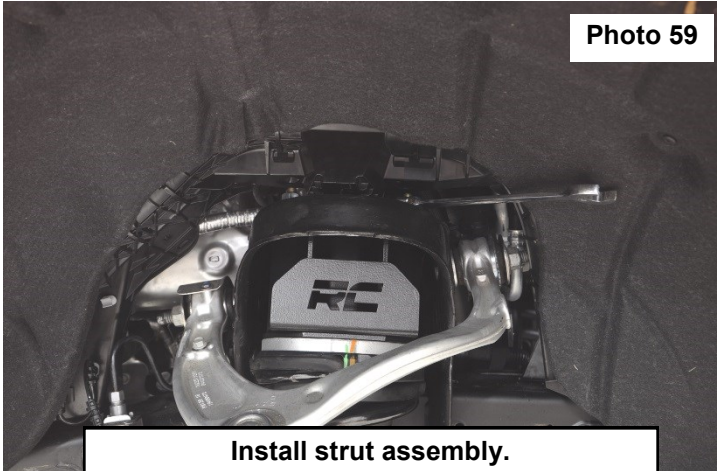

68. Carefully, install the O-ring in the supplied lifted knuckle. **See Photo 64.**

69. Install the hub bearing in the new knuckle using the factory hardware. Torque to 126ft/lbs using an 18mm socket. **See Photo 65.**

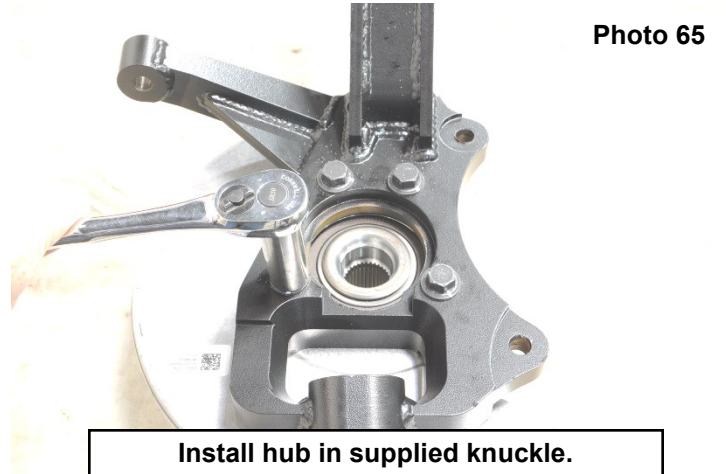
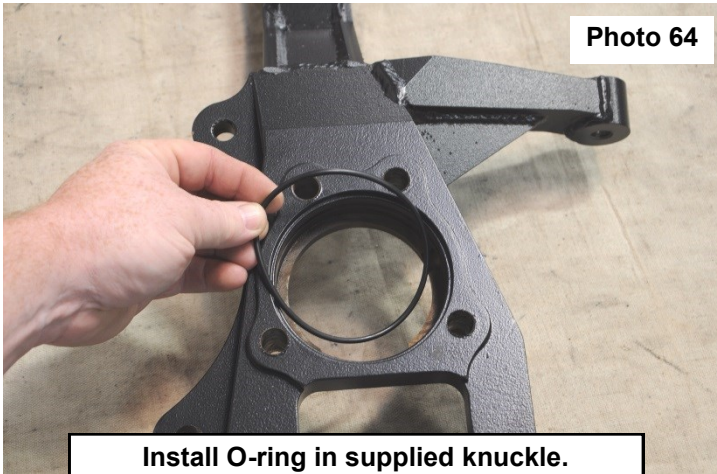

70. **2wd models skip to the next step.** Install the supplied CV spacer, **chamfer toward the CV joint**, onto the CV shaft. **See Photo 66.**

71. Install the knuckle assembly on the lower ball joint, using factory hardware, while installing the CV axle through the hub

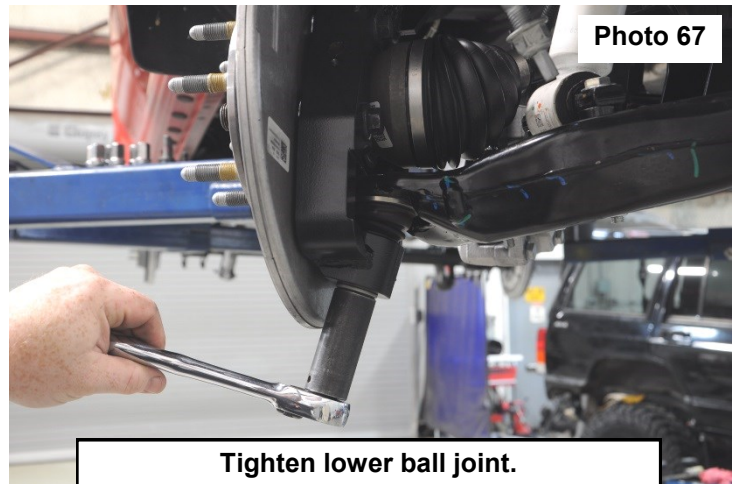
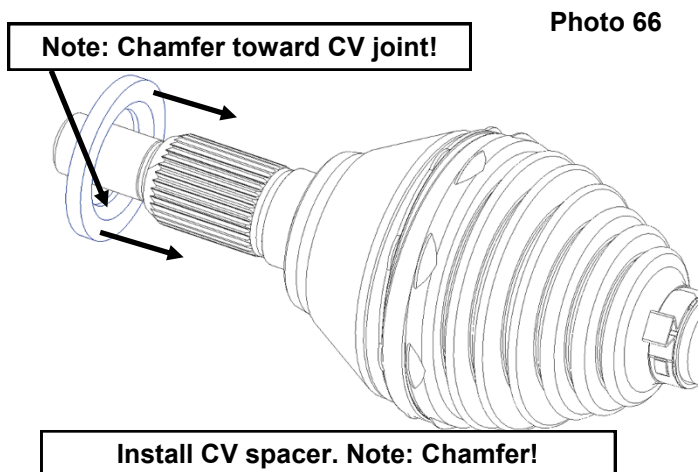

bearing. Torque using a 24mm socket to 40ft/lbs + 90°. **See Photo 67.**

72. Attach the upper ball joint using the factory hardware. Torque to 40ft/lbs + 90° using an 18mm wrench. **See Photo 68.**

73. Attach the sway link to the lower control arm using the factory hardware. Torque to 45ft/lbs using an 18mm socket.

74. **2wd models skip to the next step.** Install the CV axle nut and torque to 156ft/lbs using a 36mm socket. **See Photo 69.**

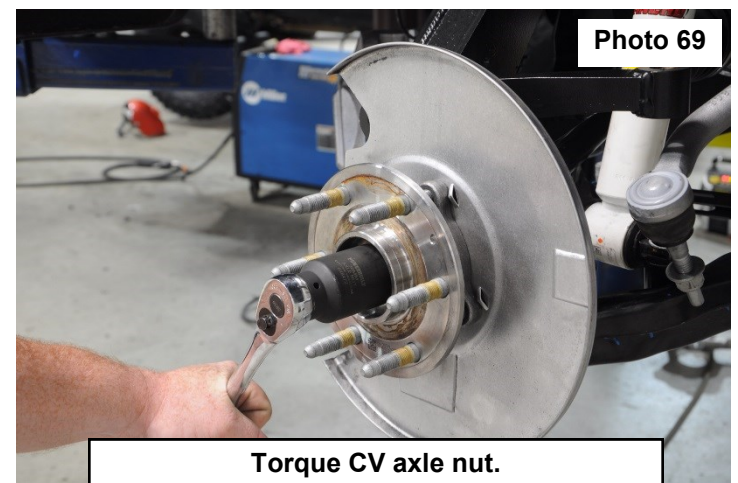
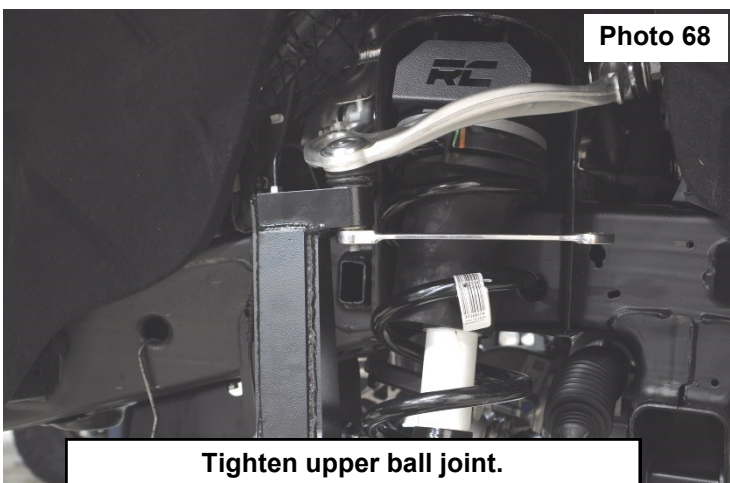

75. Install the rotor using the factory hardware, tighten using a T30 torx.

76. Install the brake caliper using the factory hardware. Plug in brake pad wear sensor. Torque to 130ft/lbs using an 18mm socket. **See Photo 70.**

77. **2020 Models skip to next step.** Attach brake line to the knuckle using the factory hardware. Tighten using a 10mm socket. **See Photo 71.**

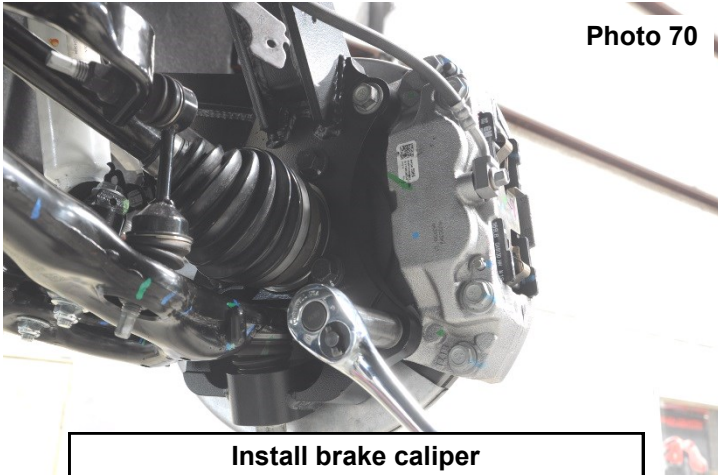

**Install brake caliper**

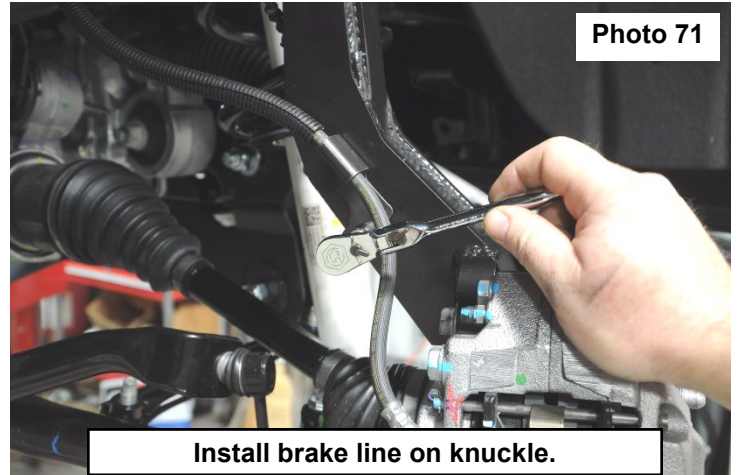

**Install brake line on knuckle.**

78. **2019 Models skip to next step.** Install the supplied brake line relocation brackets (217BAG6) on to the knuckle using the factory hardware. Tighten using a 10mm socket. Attach the factory brake line bracket to the new supplied bracket using the supplied 1/4" x 3/4" bolt and nut (217BAG6). Tighten using a 7/16" socket and wrench. **See Photos**

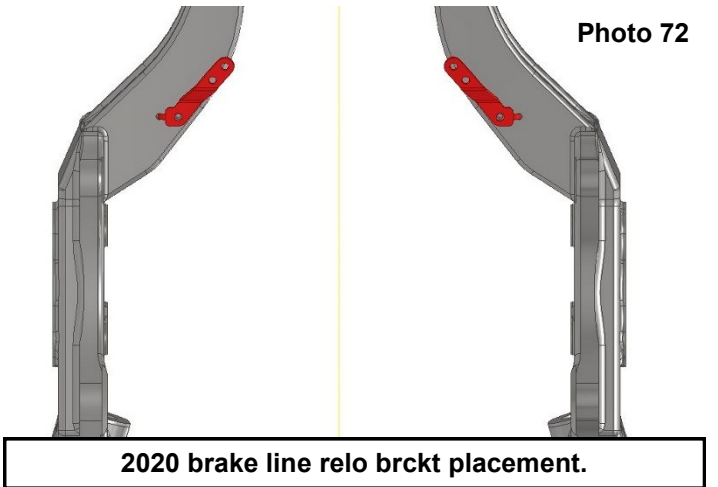

**2020 brake line relo brckt placement.**

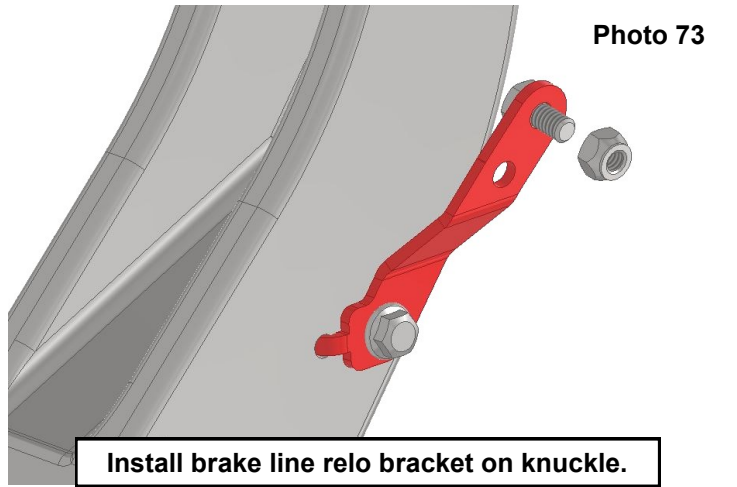

**Install brake line relo bracket on knuckle.**

**72 & 73.**

79. Attach the ABS sensor to the knuckle using the factory hardware. Tighten using a 10mm socket. **See Photo 74.**

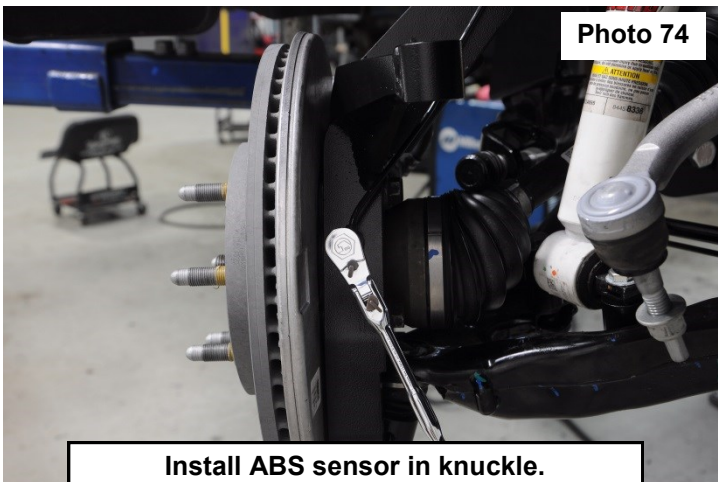

**Install ABS sensor in knuckle.**

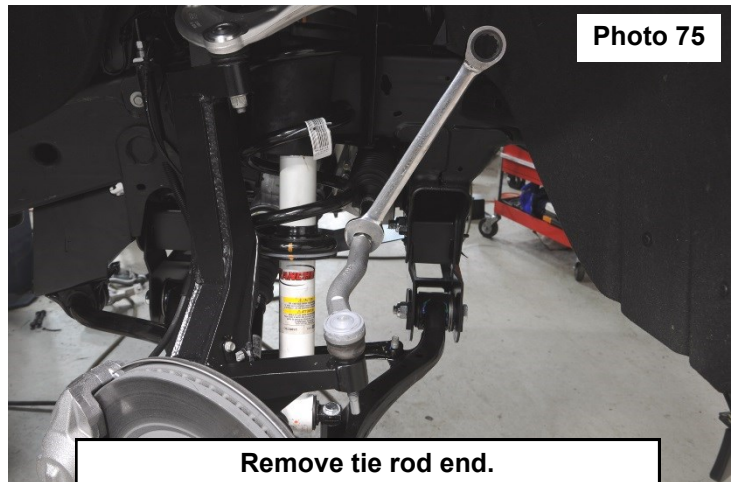

**Remove tie rod end.**

80. Place the tie rod end into the knuckle to hold it, using a 24mm wrench, remove the tie rod end. **See Photo 75.**

81. **Photo 76** shows the factory tie rod end and the new supplied tie rod end.  
 82. Install the supplied tie rod end using the supplied hardware. Torque to 32ft/lbs using a 21mm and 10mm wrenches. Tighten the jam nut using a 24mm wrench. **See Photo 77.**

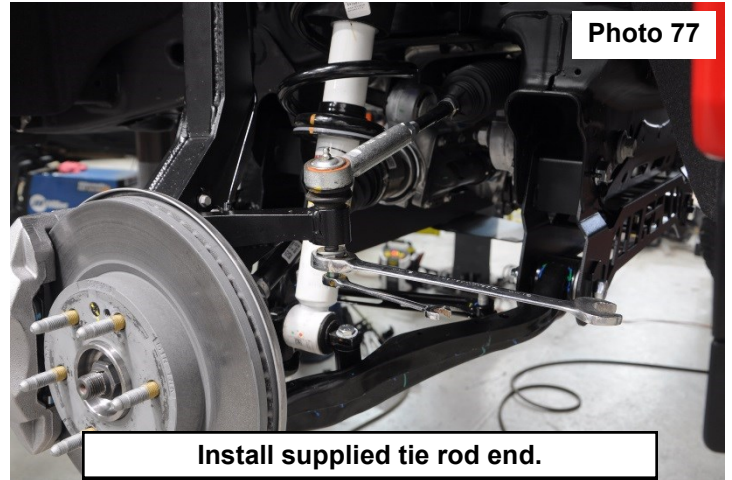
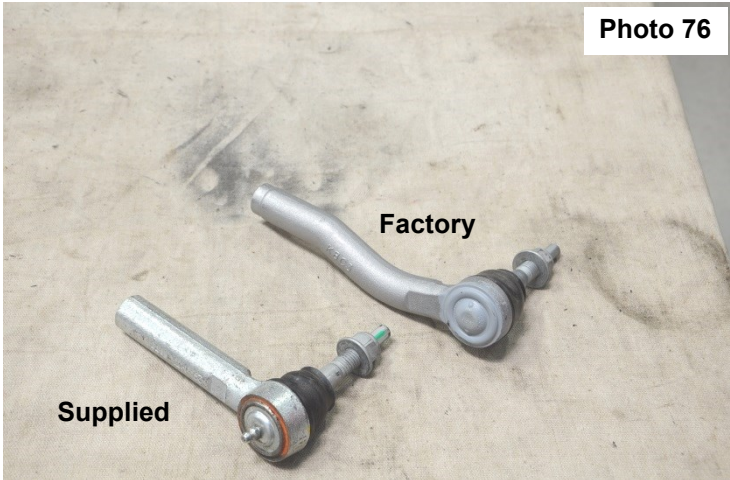

83. Repeat steps 65-82 on the opposite side of the vehicle.  
 84. Reconnect the plugs to the rack and pinion and the differential actuator. **See Photo 78.** 2wd models will not have the differential plug.  
**NOTE: Skip to step 86 for non-Trailboss/AT4 models.** Installing the skid plate is optional on 2wd models.  
 85. For Trailboss/AT4 models, remove the bumper bolts using a 10mm socket/wrench. Remove upper bolt and remove the cover. **See Photo 79.**



Plug in rack and pinion and diff actuator.

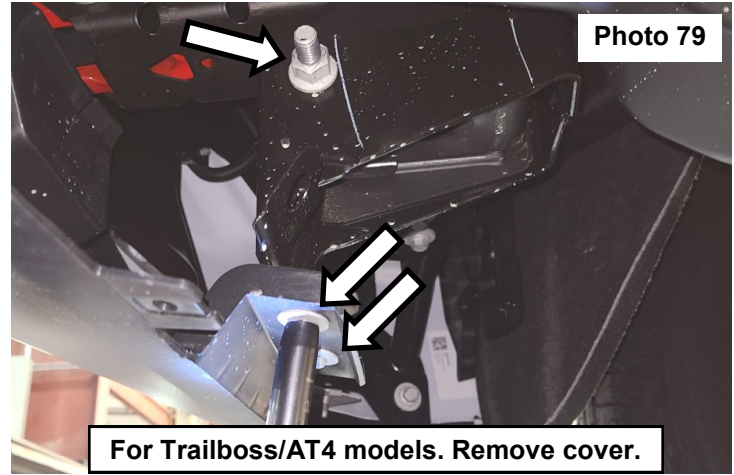

86. **Models with an intercooler (2.7l and 3.0l Diesel) will not install the front skid plate. Instead, install the front crossmember badge from 217BOX10 and skip to step 87.** Install the supplied front skid plate on the frame using the supplied 3/8" x 3.75" bolts, flat washers and nylock nuts (217BAG2). Do not tighten at this time. **See Photo 80.**  
 87. Install the supplied lower skid plate using the supplied 3/8" x 1" bolts, flat washers, and lock washers (217BAG2). Torque to 30ft/lbs using a 9/16" socket. **See Photos 81 & 82.**

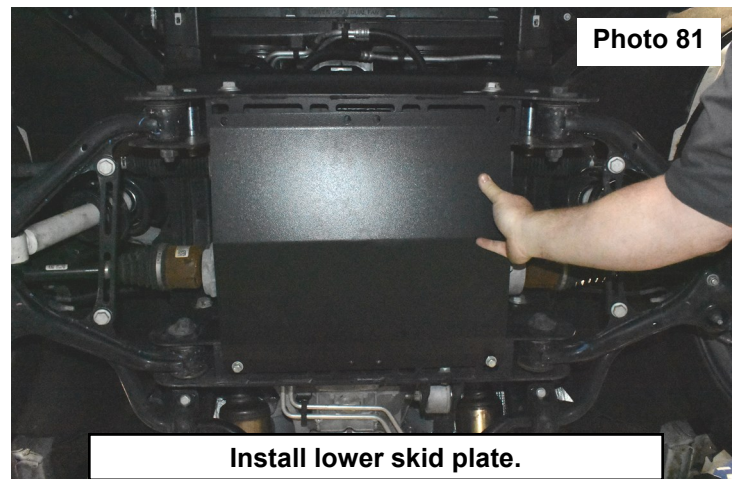
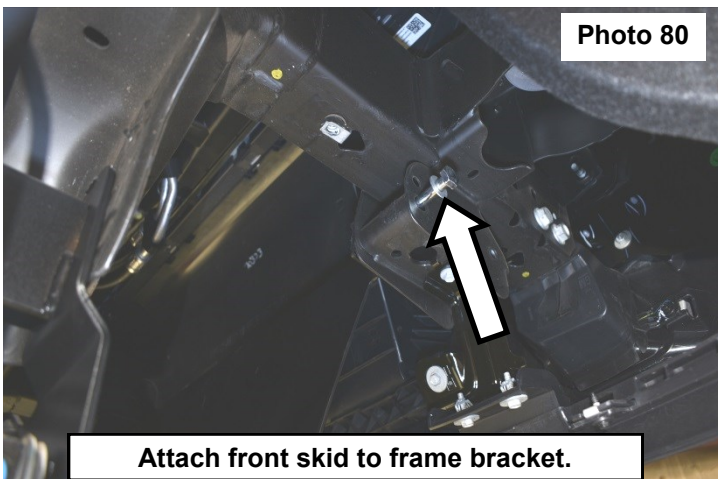
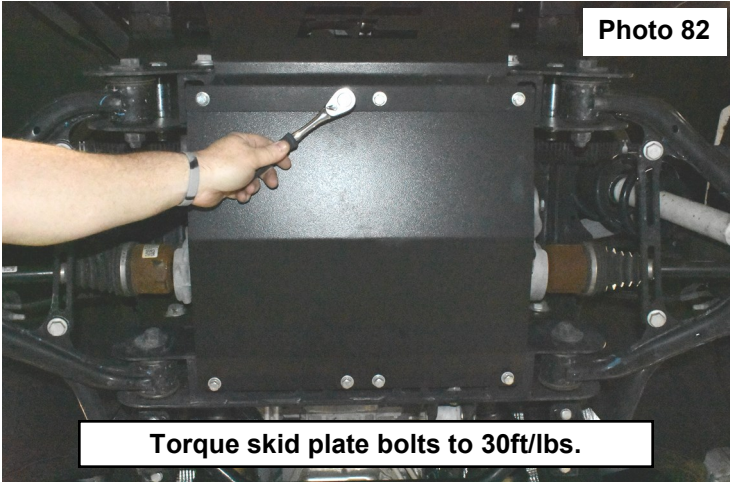

Photo 82



Torque skid plate bolts to 30ft/lbs.

- 87. Torque the front skid plate frame bolts to 30ft/lbs using a 9/16" socket and wrench.
- 88. Install the wheels and tires.

**⚠ WARNING** Take caution when installing the wheels, making sure they completely clear the brake caliper. Any pressure on the brake caliper from the wheel will cause an error in the brake system. The braking system will not function properly. The vehicle will have to be reset by a GM dealership.

- 89. Jack up the truck and remove the jack stands. Lower the truck to the ground.
- 90. Using a 27mm wrench and socket, tighten the cam bolts on the lower control arms. Torque to 240ft/lbs.
- 91. Connect the battery cables to the battery.



## REAR INSTALLATION

1. Chock the front tires.
2. Jack up the rear of the truck and place jack stands under the frame rails, lower the truck onto the jack stands allowing the rear suspension to hang. Place a jack under the rear differential.
3. Using a 21mm socket and wrench, remove the rear shocks. Retain hardware.
4. Using a 13mm wrench, remove the brake line bracket from the frame. **See Photo 1.**
5. Install the supplied brake line bracket using the stock hardware at the frame and the supplied 5/16" x 1" bolts, washers, and nuts (217BAG1) to secure the supplied bracket to the factory bracket. Torque the factory hardware to 18ft/lbs using a 13mm socket. **See Photo 2.**

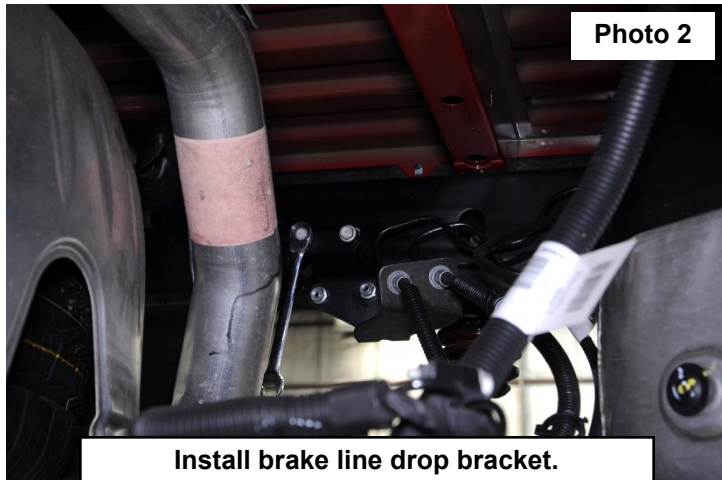
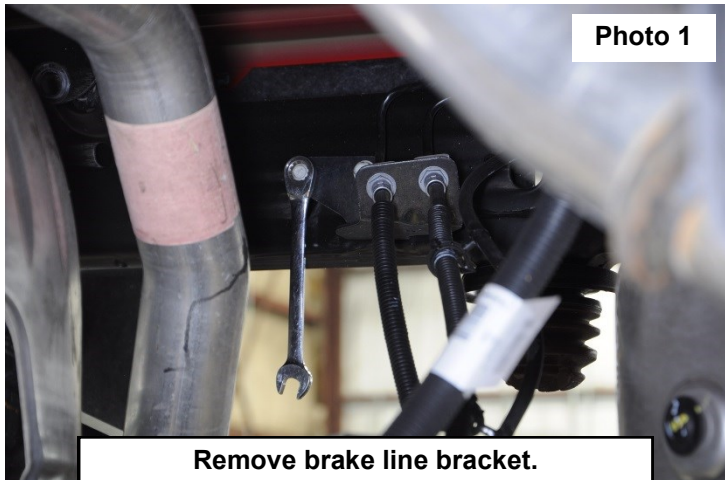

6. Torque the 5/16" hardware, using a 1/2" wrench and socket, to 15ft/lbs. **See Photo 3.**
7. Using a 13mm socket, remove the 3 bolts that attach the ABS and brake line bracket to the rear differential. **See Photo 4.**

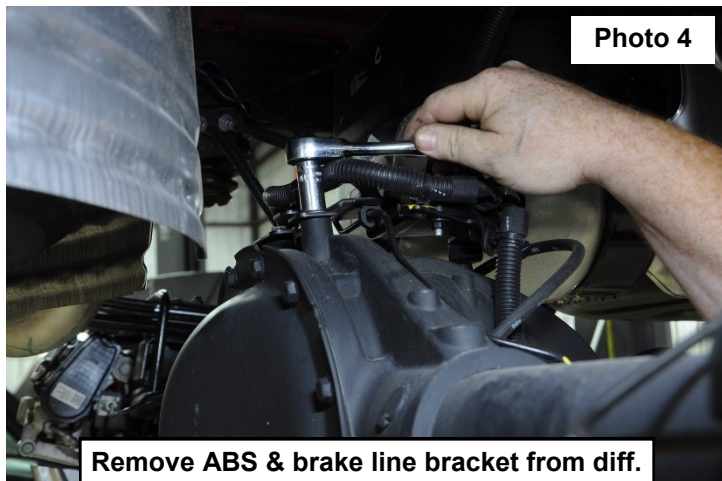
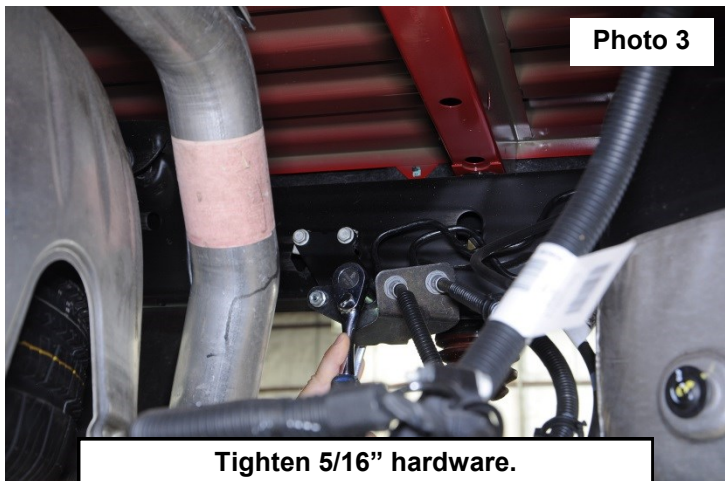



8. Attach the supplied brackets onto the differential, facing forward, using the factory hardware.
9. Attach the brake line and ABS bracket to the supplied brackets using the supplied 5/16" hardware (217BAG1). Torque the factory hardware to 18ft/lbs using a 13mm socket and the 5/16" hardware to 15ft/lbs using a 1/2" socket and wrench. **See Photo 5.**
10. Lightly support the differential with a floor jack .
11. Using a 21mm socket, remove the stock u-bolts and lower the axle.
12. Using a C-clamp on each side of the center pin, use a 15mm socket to remove the center pin. Retain hardware. **See Photo 6.**

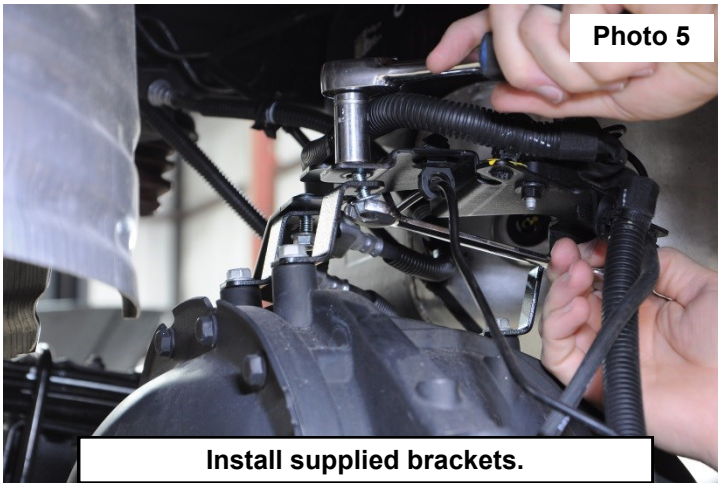

**Install supplied brackets.**

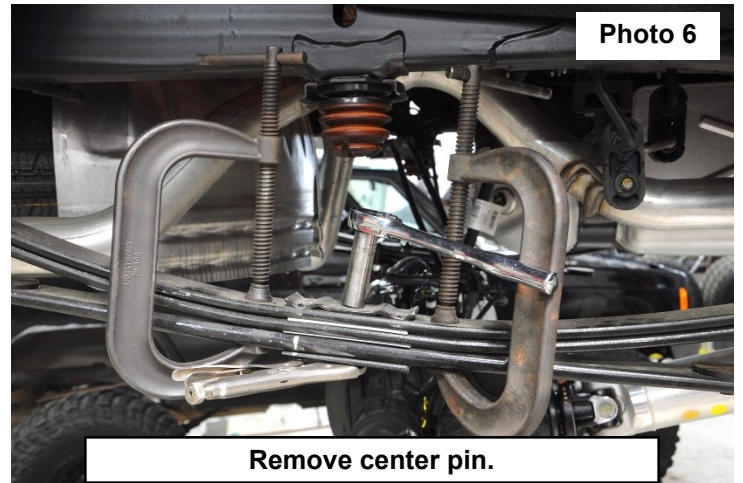

**Remove center pin.**

13. Remove the angle shim from the leaf pack. **See Photo 7.**
14. Install the factory center pin using a 15mm socket and locking pliers. Remove C-clamps. **See Photo 8.**

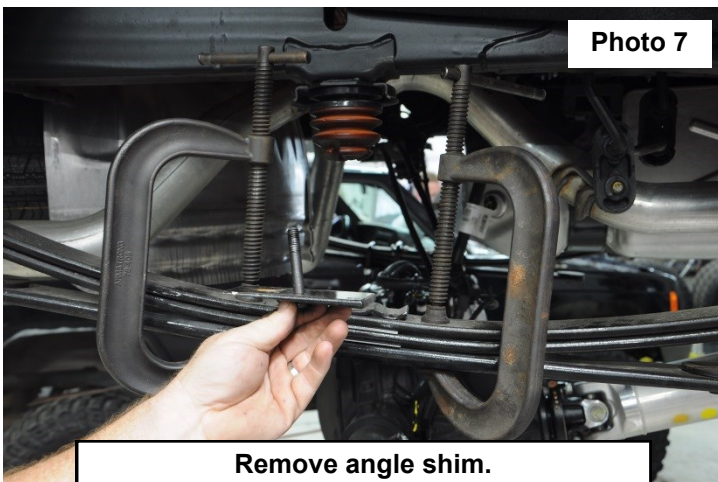

**Remove angle shim.**

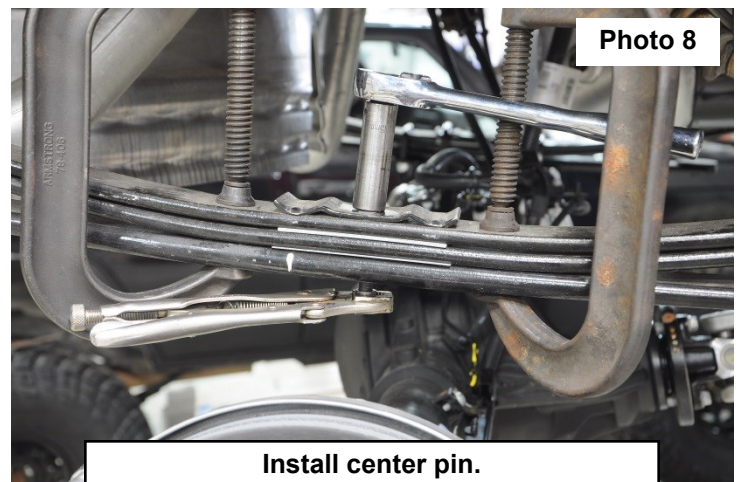

**Install center pin.**

15. Install the new block with the supplied 7/16" X 3" u-bolts on the leaf spring. Do not tighten at this time. Jack up the axle to meet the new block and make sure the center pin is in the axle. Tighten 7/16" u-bolts. Torque to 45ft-lbs. **See Photo 9. Note short side of block goes towards front of vehicle.**
16. Install the supplied u-bolts and tighten using a 22mm socket and a crossing pattern. Torque to 90ft-lbs. **See Photo 10.**

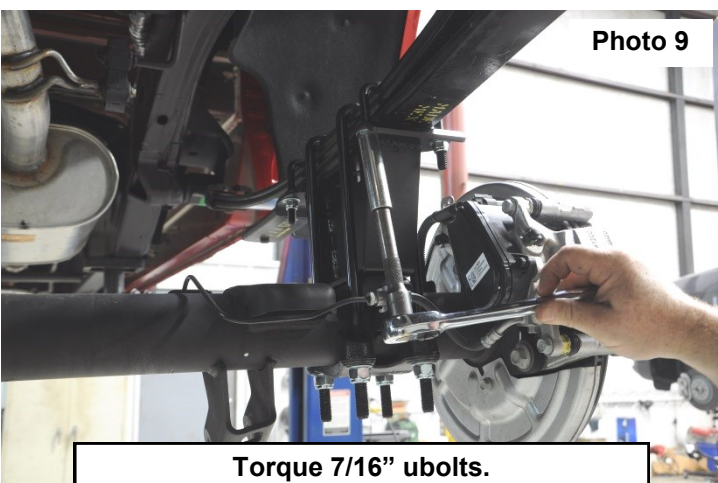

**Torque 7/16" ubolts.**

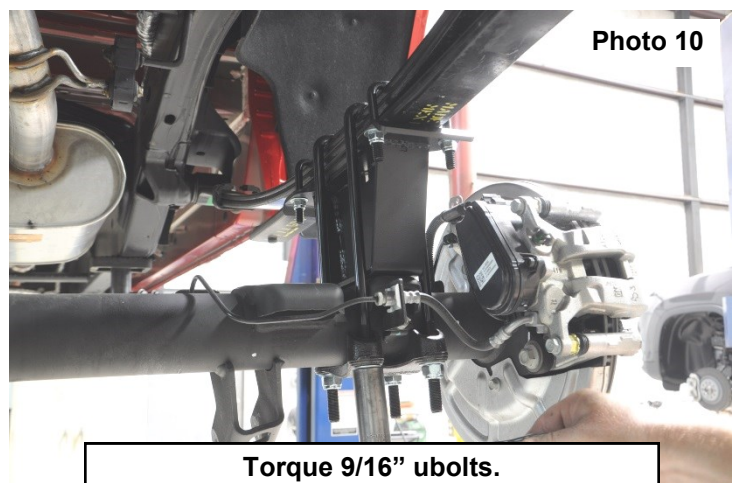

**Torque 9/16" ubolts.**

17. If installing kit with Adaptive Ride Control skip to step 19.

18. Install shock absorbers #660739 in the factory location tighten using a 21mm wrench and socket. See Photos 11 & 12. Torque to 80ft/lbs. If installing V2 rear shocks or Vertex rear shocks, refer to installation instructions included with those shocks.

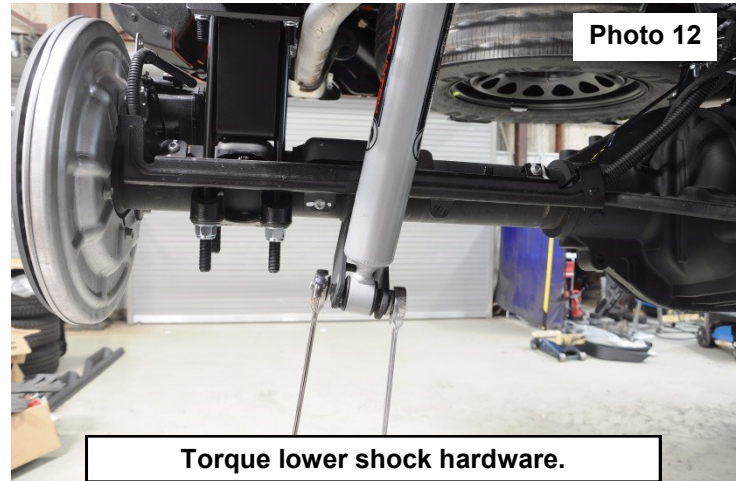
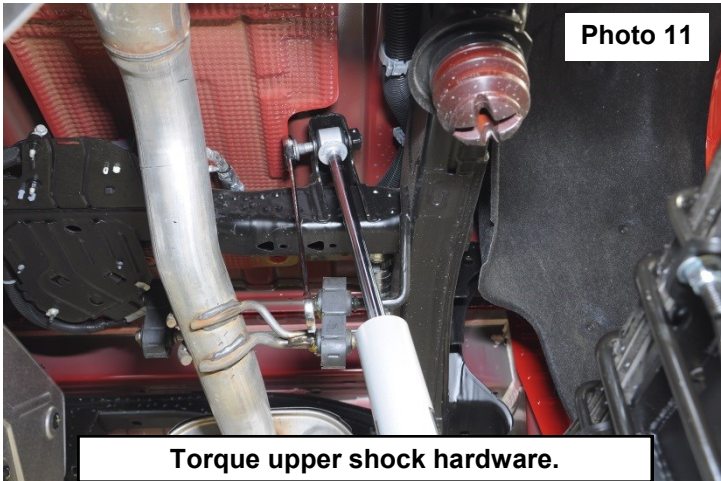

19. Install the Adaptive Ride Control shock relocation brackets in the factory shock mounts using the supplied 9/16" x 3.5" bolt, nut and washers (217BAG5). Attach the rear of the relocation bracket using the supplied square washer and 1/2" x 1.5" bolt and washer (217BAG5). Do not tighten at this time. See Photo 13.

20. Install Adaptive Ride Control shock in relocation bracket using stock hardware. Torque to 80ft/lbs. Torque the 9/16" hardware to 95ft/lbs using a 13/16" socket and wrench. Torque the 1/2" hardware to 90ft/lbs using a 3/4" socket and wrench. See Photo 14.

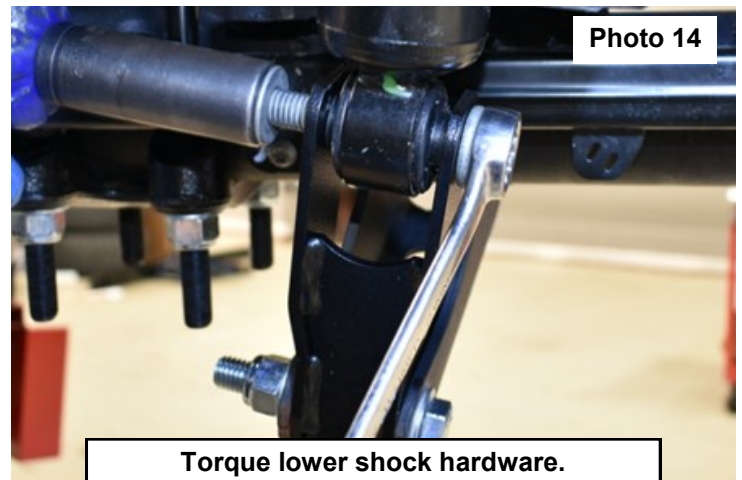
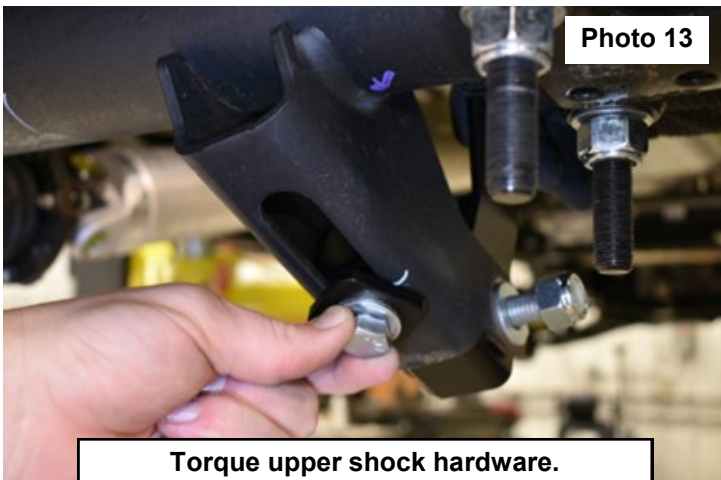

21. Re-install tires and wheels.

**⚠WARNING**

Take caution when installing the wheels, making sure they completely clear the brake caliper. Any pressure on the brake caliper from the wheel will cause an error in the brake system. The braking system will not function properly. The vehicle will have to be reset by a GM dealership.

22. Remove jack stands and lower vehicle to ground.

23. Place shock decals on shock absorbers and window decal on vehicle.

## POST INSTALLATION INSTRUCTIONS

1. Check all fasteners for proper torque. Check to ensure for adequate clearance between all rotating, mobile, fixed, and heated members. Verify clearance between exhaust and brake lines, fuel lines, fuel tank, floor boards and wiring harness. Check steering gear for clearance. Test and inspect brake system.
2. Perform steering sweep to ensure front brake hoses have adequate slack and do not contact any rotating, mobile or heated members. Inspect rear brake hoses at full extension for adequate slack. Failure to perform hose check/ replacement may result in component failure.
3. On some vehicles the front lower skirting will need to be trimmed if using certain wheel /tire combinations and with heavy offset wheels. Trim only as needed.
4. Activate four wheel drive system and check front hubs for engagement.
5. Have a qualified alignment center align the vehicle immediately. Realign to factory specifications. The following are the recommended specifications:

|                   |            |
|-------------------|------------|
| Caster in degrees | 4.0 +/-1.0 |
| Camber in degrees | -.4 +/- .8 |
| Toe In in degrees | 0.1 +/- .2 |
6. Perform head light check and adjustment to proper settings.
7. Check and retighten wheels at 50 miles and again at 500 miles.
8. All kit components must be retightened at 500 miles and then every three thousand miles after installation. Periodically check all hardware for tightness.
9. Install "Warning to Driver" decal on sun visor

Note: Installation of larger tires will require speedometer recalibration.





**Thank you for choosing Rough Country for all of your suspension needs.**

By purchasing any item sold by Rough Country, LLC, the buyer expressly warrants that he/she is in compliance with all applicable Federal, State, and Local laws and regulations regarding the purchase, ownership, and use of the item. It shall be the buyers responsibility to comply with all Federal, State and Local laws governing the sales of any items listed, illustrated or sold. The buyer expressly agrees to indemnify and hold harmless Rough Country, LLC for all claims resulting directly or indirectly from the purchase, ownership, or use of the items.

