

VIAIR®

Your Vital Air Source



50009 – MOBILE PLAYGROUND CONSTANT DUTY OBA
50011 – STEALTH PLAYER HEAVY DUTY OBA
50013 – ROAD WARRIOR CONSTANT DUTY OBA
USER MANUAL



*PARTS INCLUDED IN THE PRODUCT PHOTO MAY VARY.

IMPORTANT:

It is essential that you and any other operator of this product read and understand the contents of this manual before installing and using this product.

SAVE THIS MANUAL FOR FUTURE REFERENCE



ADVENTURE SERIES TOYHAULER DUAL ONBOARD AIR SYSTEM

Thank you for purchasing this complete, self-contained onboard air system. Contained in one package, you'll find everything you'll need to install a high performance, onboard air source for your vehicle. Please follow these instructions to install your new system.

OBA Components:

(P/N 50009) 1 - 1.5 Gallon, 6 port VIAIR® Air Tank (Max. 200 PSI), 2 - 380C Pewter VIAIR® compressors

(P/N 50011) 1 - 2.0 Gallon, 6 port VIAIR® Air Tank (Max. 150 PSI), 2 - 400C Stealth Black VIAIR® compressors

(P/N 50013) 1 - 2.5 Gallon, 6 port VIAIR® Air Tank (Max. 200 PSI), 2 - 444C Stealth Black VIAIR® compressors

Air Tank Installation:

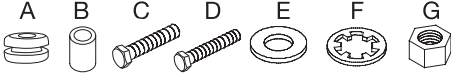

See Fig. 1 below for Mounting Hardware Assembly

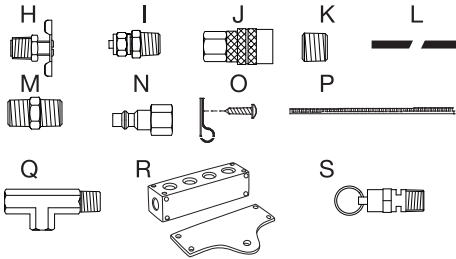

- A. Vibration Isolators (6 pcs)
- B. Brass Inserts (6 pcs)
- C. Mounting Bolts (M11 x 35mm) (4 pcs)
- D. Mounting Bolts (M11 x 45mm) (2 pcs)
- E. Washers (4 pcs)
- F. Locking Washers (4 pcs)
- G. Hex Nuts (4 pcs)
- H. 1/4" NPT Drain Cock (1pc)
- I. 1/4" NPT Compression Fittings (3pcs)
- J. 1/4" NPT F Quick Connect Coupler (1pc)
- K. 1/4" NPT M Plugs (2pcs) (PNs 50009, 50011)
- 1/4" NPT M Plugs (7pcs) (PN 50013)
- L. 1/4" O.D. Air Line 15ft (1pc)
- M. Reducer 1/4" NPT (M) - 1/4" NPT (M) (1pc)
- N. 1/4" NPT F Quick Connect Stud (1pc)
- O. 3 Air Line Clips with screws (3pcs)
- P. 5" Continuous Grommet (1pc)
- Q. 1/4" M x 1/4" F x 1/4" F, NPT, T-Fitting (1pc) (PNs 50009, 50013)
- R. 6-Port Billet Manifold & Bracket (PN 50013)
- S. Safety Valve 175PSI (PN 50011)
- Safety Valve 250PSI (PNs 50009, 50013)

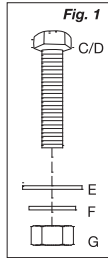

Pressure Switch & Relays:

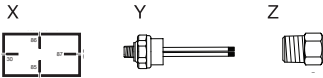

- X. 40-Amp Sealed relay (2pc) (PN 50013)
- 40-Amp Relay (2pcs) (PNs 50009, 50011)
- Y. Pressure Switch (165 On, 200 OFF) (PN 50009)
- Pressure Switch (110 On, 145 OFF) (PN 50011)
- Sealed Pressure Switch (165 On, 200 OFF) (PN 50013)
- Z. Reducer 1/4" NPT (M) - 1/8" NPT (F) (1pc)

Gauge Panel Installation:

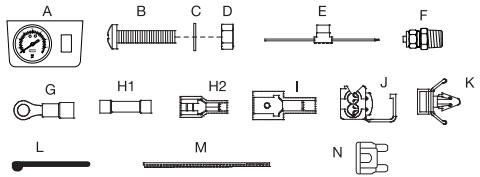

- A. Illuminated Dash Panel Gauge with On/Off Switch (1pc)
- B. Mounting Bolts (2pcs)
- C. Locking Washer (2pcs)
- D. Nuts (2pcs)
- E. 20ft. Extension Lead Wire with Inline Fuse / Fuse Holder (1pc)
- F. 1/8" (F) NPT Compression Fitting for 1/4" O.D. Air Line (1pc) (Pre-Installed)
- G. Ring Terminals (3pcs)
- H1. Insulated Female Terminal Connectors (2pcs)
- H2. Insulated Female Terminal Connector (1pc)
- I. Insulated Male Terminal Connectors (2pcs)
- J. Quick Splice Connectors (2pcs)
- K. Cable Tie Brackets (3pcs)
- L. Cable Ties (6pcs)
- M. Continuous Grommet (1pc)
- N. Fuse (2pcs)*

Compressor Installation:

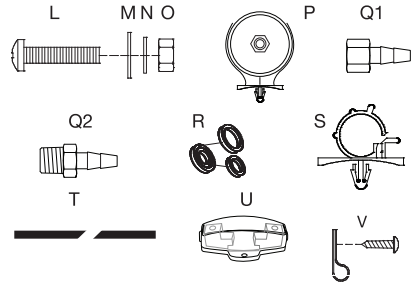

- L. Mounting Bolts (8pcs)
- M. Flat Washers (16pcs)
- N. Locking Washers (8pcs)
- O. Nuts (8pcs)
- P. Remote Mount Air Filter Assemblies (2pcs)
- Q1. 1/4" NPT F x 3/8" Barbed Fitting (2pcs)
- Q2. 1/4" NPT M x 3/8" Barbed Fitting (2pcs)
- R. 2-pack of Replacement Air Filter Elements (2pcs)
- S. Leader Hose Bracket Clips (2pcs)
- T. 3/8" O.D. Air line 6ft (2pcs, for remote mounting filter assembly)
- U. Mini ANL Fuse Holder (1pcs)
- (2 Mini ANL 80 Amp Fuses Included.) (PN 50011)
- (2 Mini ANL 60 Amp Fuses Included.) (PNs 50009, 50013)
- V. Air clips with Screws (6pcs)

ADVENTURE SERIES TOYHAULER DUAL ONBOARD AIR SYSTEM

PARTS PACKAGES (CONT'D)

Coil Hose with Couplers:

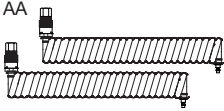

- AA. 30ft. Coil Hose with close ended
1/4" Quick Connect Coupler & Stud

Air Tools / Carry Bag:

GG

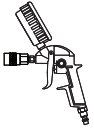

HH

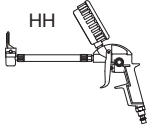

- GG. Mechanical Tire Inflation Gun with 0-160 PSI (P/N 50011)
Digital Tire Inflation Gun with 0-180 PSI (P/N 50013)
HH. Mechanical Tire Inflation Gun with 0-200 PSI (P/N 50009)

II



- II. Rubber Tipped Blow Gun

LL

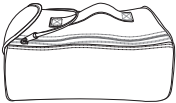

- LL. VIAIR® Storage Bag w/Zipper

MM



- MM. 45° Dually Chuck (Extended Reach Chuck) (P/N 50013)

NN



- NN. 90° Twist-On Chuck Air Hose Length: 40 in.
(PNs 500011, 50013)

ADVENTURE SERIES TOYHAULER DUAL ONBOARD AIR SYSTEM

AIR TANK & PLUMBING

The tank comes with six 1/4" NPT port openings to allow installation in many configurations on your vehicle. To ensure safe and trouble-free use of your air tank, we strongly recommend that you install the supplied drain cock and a safety pressure relief valve. (See Figure 1)

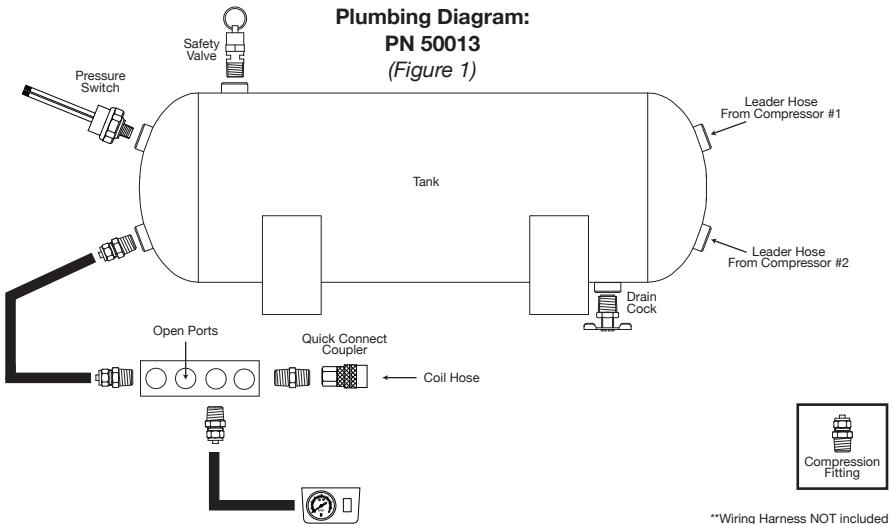
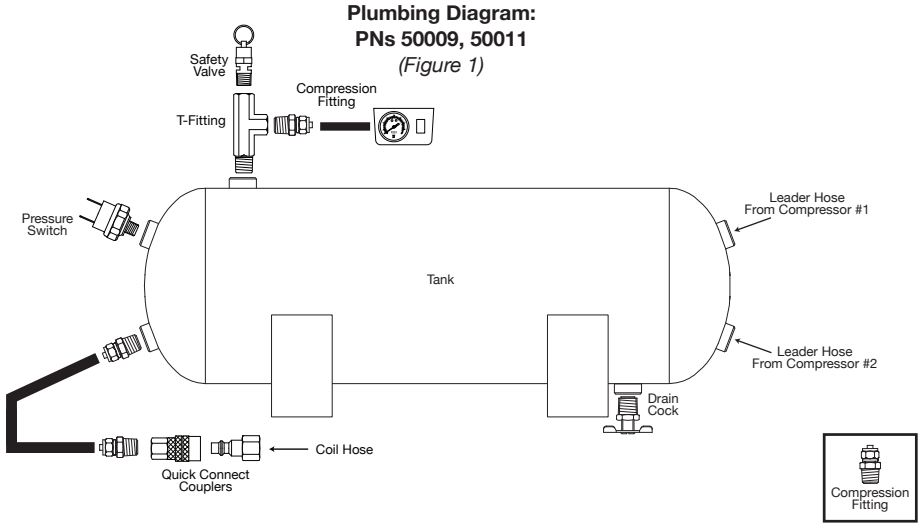

**Wiring Harness NOT included

Tank Fittings:

Install the supplied fittings for the air tank in areas where they are most appropriate for your installation using thread sealant. (Not all installations will be plumbed exactly as shown in schematic.) Make sure that the safety valve is installed in the top most position on the tank, and that the drain cock is installed in the lowest position on the tank if the tank is to be installed in any other position than upright on the tank's mounting legs. Be sure that all fittings are accessible later in the installation process since you will have to plumb air lines to each fitting as needed to utilize the air tank.

ADVENTURE SERIES TOYHAULER DUAL ONBOARD AIR SYSTEM

AIR TANK & PLUMBING (CONT'D)

Mounting the Tank:

We have included 6 pieces of rubber bushings in your tank mounting hardware. You have the option of using two layers of rubber bushings on one of your tank legs to slightly tilt tank toward the drain cock port to improve drainage properties. Use the provided longer bolts, and corresponding washers, lock washers and nuts to mount the tank to a suitable chassis or other place on your vehicle.

IMPORTANT:

- Tank is rated for 150 PSI maximum working pressure. (P/N 50011)
- Tank is rated for 200 PSI maximum working pressure. (P/Ns 50009, 50013)
- Tank is **NOT** to be used as a breathing device.
- Use only attachments or tools rated for 150 PSI working pressure or less. (P/N 50011)
- Use only attachments or tools rated for 200 PSI working pressure or less. (P/Ns 50009, 50013)

CAUTION! DO NOT PRESSURIZE YOUR TANK UNTIL YOU HAVE INSTALLED ALL NECESSARY PORT FITTINGS AND ACCESSORIES.

- Apply sealant to threads of fittings prior to assembly and tighten each part with a wrench.
- Do not over tighten if your port fittings are made from brass, since brass threads can be stripped.
- Bleed pressure from tank before servicing or adding attachments.

WARNING: FAILURE TO DRAIN TANK AND REMOVE CONDENSATION WILL CAUSE TANK TO RUST PREMATURELY.

- To remove accumulated condensation inside the tank, bleed pressure from tank using the drain cock until pressure is approximately 5-20 PSI.
- Drain tank by opening the drain cock drain valve and close after draining tank.
- If drain cock valve is plugged, release all air pressure from tank, remove drain valve and clean, then reinstall.

IMPORTANT: Please observe air tank's Date of Manufacture (stamped on tank leg).

Replace air tank 2 to 5 years from date air tank was first used, or use the date of manufacture as reference. Adhering to air tank draining guidelines will prolong the life of your air tank.

PLEASE NOTE: RUSTED TANKS CAN FAIL CAUSING EXPLOSIONS OR FATAL INJURIES.

Discard tank immediately if tank is rusted.

SAFETY VALVE: When using a safety pressure relief valve, point the safety pressure relief valve away from your body when releasing air. Use the pull ring on the safety relief valve to vent pressure from the tank before servicing.

DUAL AIR COMPRESSOR INSTALLATION

Please follow these installation instructions to enjoy the best use of your onboard air system.

CAUTION - To reduce risk of electrical shock or electrocution:

- Do not disassemble the compressor. Do not attempt repairs or modifications.
Refer to qualified service agencies for all service and repairs.
- Do not use this product in an area where it can fall or be pulled into water or liquids.
- Do not reach for this product if it has fallen into liquid.
- Use this compressor with 12-Volt DC systems only.
- This product should never be left unattended during use.

DUAL AIR COMPRESSOR INSTALLATION (CONT'D)

Guidelines for Selecting Mounting Location:

The selection of proper mounting location for your air compressor will help ensure a long and trouble free compressor service life. Please pay close attention to the following:

- Select a FLAT, UPRIGHT, & SECURE LOCATION where the compressor can be mounted.
- To maximize air compressor performance, locate compressor as CLOSE TO THE BATTERY as possible so that length of positive lead wire required is at a minimum.
- Choose mounting location that is as cool as possible and away from heat sources.
- This compressor is moisture & dust resistant, but NOT WATERPROOF or DUSTPROOF. Do not mount compressor in locations where the unit is likely to come in contact with water or excessive dirt.
- For compressor with remote filter mounting, select compressor's mounting location where air line can be routed from compressor air inlet to remote inlet air filter. Make sure that the remote inlet air filter is located in a dry location, away from water.
- You will also want to select a compressor mounting location where the leader hose bracket can be mounted to secure the leader hose.
- If it is necessary to mount the air compressors further from the battery, such as inside your vehicle or in the bed of your pickup, use a minimum 8 AWG positive lead wire for remote installation for each compressor.
- Do not mount compressor near areas where flammable liquids are stored.
- Use thread sealant for proper fitting installation. Thread tape is not recommended. Properly sealed, recommended torque for 1/4" and 3/8" is 12~15 ft. lbs.

Compressor Wiring: (See Figure 3 on back of manual)

1. Disconnect ground cable from vehicle's battery.
2. Temporarily position the air compressor in the location where it will be mounted.
3. Route ground wire to the negative post of the battery or to an appropriate grounding point and cut ground wire to length as needed.
4. Mount the air compressors with the eight sets of 13/64" (5 mm) bolts, nuts, washers, and locking washers provided. Use of thread locker is recommended.
5. NOTE: For Remote Inlet Air Filter Installation, refer to Remote Inlet Air Filter Installation Instructions included in the Remote Inlet Air Filter Pack.
6. This air compressor comes with a heavy duty heat resistant stainless steel braided leader hose with 1/4" NPT fittings.
7. IMPORTANT: Please note; the leader hose that came with your compressor has a built-in inline check valve pre-installed. Do not remove inline check valve from leader hose.
8. Select a proper location to mount leader hoses with hose brackets provided. Avoid locations where leader hose may become tangled with wires and other hoses.
9. To mount hose bracket, drill holes with 3/16" drill bit and push self-anchoring hose bracket pin into hole. Route leader hose through hose bracket and secure hose by pressing bracket clamp into locked position.
10. To remove hose from the hose bracket, simply press down on the hose clamp release tab to release bracket clamp.
11. Follow wiring diagram on the back of manual (Fig. 3)
12. Make sure that your compressor setup is properly fused. (*Mini ANL Fuses included*).
Dual 380C compressors pull approximately 46-Amps maximum of power. Dual 400C compressors pull approximately 60-Amps maximum of power.
Dual 444C compressors pull approximately 46-Amps maximum of power.
13. Always locate fuse as close as possible to power source.
14. Before connecting to power source, check to make sure that all connections are made properly.
15. Connect and test compressor system by running the compressor for a short time to build up pressure in your air tank.
16. Once air pressure reaches preset cut out pressure of your pressure switch, the compressor will shut off. Inspect all air line connections for leaks with soap and water solution. If a leak is detected, the air line may not be cut squarely or pushed all the way in. Tighten connections if needed.

ADVENTURE SERIES TOYHAULER DUAL ONBOARD AIR SYSTEM

OPERATING INSTRUCTIONS

IMPORTANT: The compressors have a maximum working pressure of 150 PSI (*P/N 50011*) or 200 PSI (*P/Ns 50009, 50013*). Always operate the compressor at or below the **MAXIMUM PRESSURE RATING** of the compressor. Operation exceeding maximum pressure ratings and or duty cycle will result in damage to air compressor.

1. Your air compressor is equipped with an **AUTOMATIC THERMAL OVERLOAD PROTECTOR**. This feature will protect the air compressor from overheating and causing permanent damage to your air compressor. The thermal overload protector will automatically cut off power to your air compressor should the internal operating temperature of the air compressor rise above safe levels during excessive use.
2. Should your air compressor automatically shut off during use, turn power to the system off. The automatic thermal overload protector will automatically reset when internal temperature of the air compressor drops below safe levels. After allowing air compressor to cool off, you can safely resume use of the air compressor by turning on the system.
3. To prevent discharge of your battery and to provide peak performance, it is recommended that you keep the engine running while the air compressor is in use.
4. **ONLY OPERATE THE AIR COMPRESSOR IN WELL-VENTILATED AREAS.**

Dual Compressor Maintenance & Repairs:

1. Periodically check all electrical and fitting connections. Clean and tighten as needed.
2. Periodically check all mounting screws. Tighten as needed.
3. Replace air filter element periodically. Replacement frequency depends on operating frequency and operating environment. For frequent use in dusty environment, you should replace air filter element more often.
4. Regularly clean dust and dirt from compressor.
5. Your air compressor is equipped with permanently lubricated, maintenance-free motor. Never lubricate compressor.
6. Repairs should be performed by Manufacturer or Manufacturer's Authorized Service Agencies only.

CAUTION: Never touch the air compressor or fittings connected to the air compressor with bare hands during or immediately after use. Leader hose and fittings will become very **HOT** during and after use.

Dual Compressor Installation Tips:

1. Always use the remote intake filter option when possible. This will extend the service life of your compressor.
2. If noise reduction from vibration is desired, using the remote mount option for the inlet filter can reduce operation noise by up to 25%.
3. Always mount the compressor at a point higher than the inlet port of the tank. This will keep moisture from being able to seep back to the compressor.
4. When mounting the compressor, use a paint pen on the rubber isolators and cover the side to go against the chassis or mounting location. Then, simply stamp the compressor against the chassis to make an imprint of exactly where to drill the mounting tips for the compressor.

PRESSURE SWITCH INSTALLATION

Your VIAIR® Onboard Air System comes complete with a pressure switch that will turn on the compressor at 110 PSI and off at 145 PSI (*P/N 50011*) or 165 PSI on, and 200 PSI off (*P/Ns 50009, 50013*). The pressure switch has a 1/8" M NPT inlet and pre-applied thread sealant.

Pressure Switch and Relay Installation Tips:

1. Both terminals of the pressure switch are positive (+) leads. **(The use of a relay is always recommended).**
2. Never use a pressure switch that is rated beyond your compressor's rated Maximum Working Pressure.
3. Replace the Pressure Switch with (*PN 90103 for PN 50009*), (*PN 90102 for PN 50011*), (*PN 90221 for PN 50013*), if the pressure switch becomes faulty or fails in the future.
4. See Fig. 3 for relay and pressure switch installation tips.

DASH PANEL GAUGE INSTALLATION

Your VIAIR® Onboard Air System comes complete with a Dash Panel Gauge to monitor the pressure of your VIAIR® air tank. Additionally, the Dash Panel Gauge has an ON/OFF switch preinstalled that will allow you to turn the system off by cutting power to the pressure switch that you have already installed. We recommend that you install a master ON/OFF switch to allow the system to be turned off any time you anticipate leaving the vehicle parked for any length of time, and to avoid draining the vehicle's battery unnecessarily due to a slow air leak in your system. (See *Figure 3 on back of manual*)

IMPORTANT: Each Dash Panel Gauge has been tested and calibrated. The air inlet on this gauge has a factory installed compression fitting. DO NOT attempt to tighten or loosen the body of this compression fitting. Any adjustments will cause the gauge to malfunction and void warranty. The Dash Panel Gauge included in this kit is rated for 150 PSI (*P/N 50011*) or 200 PSI (*P/Ns 50009, 50013*). Always operate the gauge at or below the MAXIMUM PRESSURE RATING of the gauge.

1. Select Mounting Location for Dash Panel Gauge:

Select a mounting location with a rigid mounting surface such as the bottom edge of the dashboard. Use the gauge mounting panel as a template; mark off two mounting points to be drilled. Carefully drill two 13/64" diameter holes as marked. Do not mount Dash Panel Gauge at this time.

2. Air Line Connection to Dash Panel Gauge:

Remove only the collar of the compression fitting from the back of the Dash Panel Gauge. Do not loosen or tighten the body of the compression fitting, which is permanently affixed to the air inlet of the gauge. Insert air line tubing through this collar, and then push air line tubing onto the barb of the compression fitting until the air line completely covers the barb. Tighten collar onto the body of the compression fitting with a wrench.

3. Routing Air Line to Tank:

Route the air line tubing on the Dash Panel Gauge to the tank. Do not cut air line yet, in some cases a hole may need to be drilled to enable the air line to pass through panels to the tank location. Make sure that the air line tubing is protected from any sharp edges of the drilled hole using grommet strip supplied. Connect to the tank using the 1/4" compression fitting supplied.

Installation Tips:

- When cutting air line tubing, always cut as squarely as possible. Use a hose cutter or razor blade.
- When routing air line tubing, always remember to avoid sharp edges, heat sources and tight bends. (Air line must be routed at least 12 inches from exhaust systems & other heat sources.)

IMPORTANT - Drilling through firewall:

Always be sure of what is on the other side of the firewall before drilling. Take care not to damage your vehicle's electronic systems or components.

4. Wiring the ON/OFF Switch:

Attach one of the two remaining female terminal connectors to the wire that was routed from the pressure switch. There are two male spade connectors on the back of the ON/OFF switch. Connect this female terminal connector to one of the male spade connector on the ON/OFF switch. Next, attach appropriate size ring terminal provided in the kit to the end of the wire with the Inline Fuse. (The ring terminal should be about 12" from the inline fuse.) This wire is referred to as the power wire. Temporarily position the ring terminal at the power source and route power wire to the dash panel gauge, measure and cut to appropriate length. (If additional wire is necessary, use 16 AWG wire.) Attach the remaining female terminal connector to end of power wire, and connect to male spade connector on the ON/OFF switch. (Note: Do not connect gauge to power source at this time.)

5. Wiring the Dash Panel Gauge for Illumination:

There are two wires, one red and one black connected to the light bulb of the gauge. Connect the red wire to a suitable fused dash panel circuit. Use the quick splice connector included in the kit for wire connections. The black wire is to be connected to a suitable ground source.

6. Mounting the Dash Panel Gauge:

With all electrical and air line tubing routed and connected properly, mount the dash panel gauge using the two 13/64" nuts, bolts, and washers included with the Dash Panel Gauge. Make sure that no electrical wires or air line can be contacted by vehicle pedal operation, or by use of any safety equipment. Use provided zip ties to secure air line and electrical wiring.

DASH PANEL GAUGE INSTALLATION (CONT'D)

7. Connect to Power Source:

Before connecting the power wire to a power source, check to make sure that the ON/OFF switch on the dash panel gauge is in the OFF position. Connect the ring terminal of the power wire to power source. (This is the wire described in Step 4, which is connected to the ON/OFF switch of the dash panel gauge.)

8. Testing Your Onboard Air System:

Your Onboard Air System installation is now complete. Run the compressor to build pressure in the air tank. When air pressure reaches the pressure switch cut out pressure, the compressor will shut off. Inspect all air line connections for leaks with soap and water solution and spray with a spray bottle onto connections to check for leaks. If leaks are detected, air line may not be cut squarely or pushed all the way in. Fix connections as needed. Periodically check your system's fitting in this manner should your compressor turn on more often than normal without frequent air use.

ADVENTURE SERIES TOYHAULER DUAL ONBOARD AIR SYSTEM

TIRE INFLATION GUN OPERATING INSTRUCTIONS

Your Onboard Air System also comes with a Tire Inflation Gun for airing up tires and adding compressed air to any inflatable items with a valve stem.

1. Using the Tire Inflation Gun:

PN 50009:

Using a 1/4" Quick Connect Coupler, connect the Tire Inflation Gun to an air hose and connect to a tire valve stem or similar inflation collar by securing the folding lever on the Inflation Gun air chuck.

PN 50011 & 50013:

Attach one end of the extension coil hose to the compressor and the other end to the tire gun kit, 45-degree angled chuck (PN 50013) or 90-degree twist-on chuck (PNs 50011, 50013).

2. Filling Tires and other Inflatable Items:

Turn on the compressor switch on and squeeze the inflation trigger on the Inflation Gun by pressing it towards the handle of the gun. This will allow stored air from the air tank to flow through the gun and through the chuck into your tire or other inflatable items.

3. Checking Tire Pressure:

To check tire pressure, release Inflation Trigger on Inflation Gun and allow the needle of the gauge to settle. Tire pressure will be able to be read only when the inflation trigger is released.

WARNING:

- Never operate the Inflation Gun at any pressure exceeding 160 PSI (P/N 50011), 180 PSI (P/N 50013), 200 PSI (P/N 50009).
- Use caution when attaching or removing air chuck from valve stems.
- Always ensure that tire valve stems are tight before inflating tires.
- Be careful to never inflate any tire or other inflatable items past its rated pressure to avoid explosion, possible injury, or death.

Please Note: Not intended for use with regular portable compressors or units meant to be operated with an open ended air chuck. The Tire Inflation Gun is equipped with a closed ended chuck and will hold pressure back, which could cause the hose to burst.

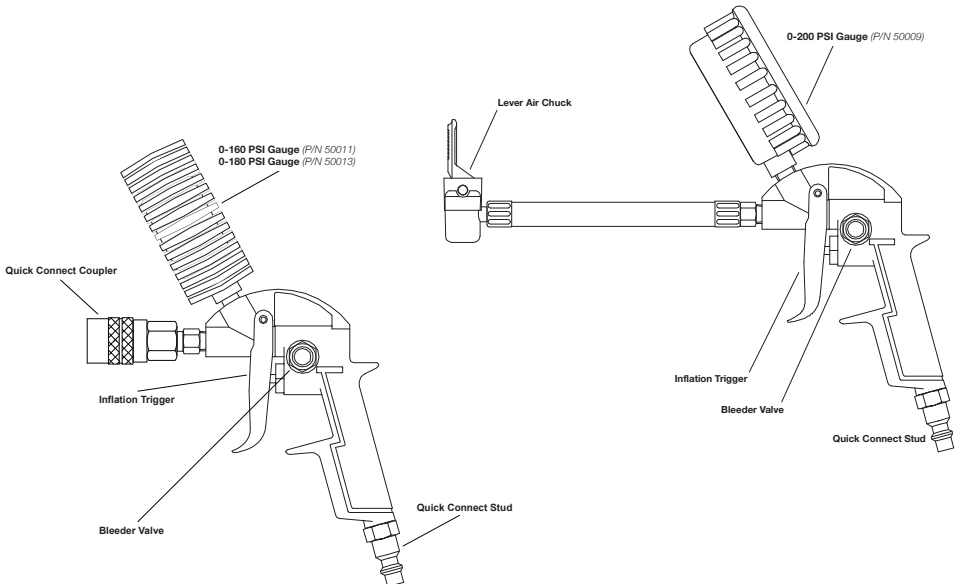

VIAIR® TIRE INFLATION GUN

USER MANUAL

ADVENTURE SERIES TOYHAULER DUAL ONBOARD AIR SYSTEM

TROUBLESHOOTING GUIDE:

PROBLEM	POSSIBLE CAUSE(S)	CORRECTIVE ACTION
Tank pressure drops when compressor(s) shut off	<ol style="list-style-type: none"> 1. Loose drain cock 2. Check valve leaking 3. Loose connections 	<ol style="list-style-type: none"> 1. Tighten drain cock 2. Replace check valve or compressor(s) 3. Check all connections with soap and water solution and tighten
Compressor runs continuously and air flow lower than normal	<ol style="list-style-type: none"> 1. Excessive air usage 2. Loose connections 3. Worn piston ring or inlet valve. 4. Clogged air filter element 	<ol style="list-style-type: none"> 1. Decrease air usage 2. Check all connections with soap and water solution and tighten. 3. Repair or replace compressor 4. Replace air filter element
Compressor runs continuously causing safety valve (if equipped) to open	<ol style="list-style-type: none"> 1. Bad pressure switch 2. Defective safety valve 	<ol style="list-style-type: none"> 1. Replace pressure switch 2. Replace safety valve
Excessive moisture in discharge	<ol style="list-style-type: none"> 1. Excessive water in air tank 2. High humidity 	<ol style="list-style-type: none"> 1. Drain tank, tilt tank to drain. Drain tank more frequently 2. Move compressor to area with less humidity, or use air line filter.
Compressor will not run	<ol style="list-style-type: none"> 1. No power, or power switch in OFF position 2. Blown fuse 3. Motor overheats 4. Faulty pressure switch. 	<ol style="list-style-type: none"> 1. Make sure compressor switch is ON 2. Disconnect compressors from power source, replace fuse. (Refer to Specifications section for correct fuse amperage.) 3. Let compressors cool off for about 30 Minutes to allow thermal overload switch reset. 4. Replace pressure switch
Thermal overload protector cuts out repeatedly	<ol style="list-style-type: none"> 1. Lack of proper ventilation or ambient temperature too high 2. Compressor valves failed 	<ol style="list-style-type: none"> 1. Move compressor to well ventilated area, or area with lower ambient temperature 2. Repair or replace compressor
Excessive knocking or rattling	<ol style="list-style-type: none"> 1. Loose mounting bolts 2. Worn bearing on eccentric or motor shaft 3. Cylinder or piston ring is worn 	<ol style="list-style-type: none"> 1. Tighten mounting bolts 2. Repair or replace compressor 3. Repair or replace compressor

CAUTION: NEVER DISASSEMBLE COMPRESSOR WHILE COMPRESSOR IS PRESSURIZED.

ADVENTURE SERIES TOYHAULER DUAL ONBOARD AIR SYSTEM

COMPRESSOR APPLICATION GUIDE

To ensure that you get the highest level of satisfaction from your compressor performance, refer to information below:

VIAIR® COMPRESSOR REFERENCE CHART

COMPRESSOR SERIES	MAX. WORKING PRESSURE	DUTY CYCLE (100 PSI @ 72°F)
090 SERIES	120 PSI	9%
092 SERIES	120 PSI	9%
095 SERIES	120 PSI	9%
097 SERIES	130 PSI	10%
098 SERIES	130 PSI	10%
100 SERIES	130 PSI	15%
250 IG SERIES	150 PSI	100%
275 SERIES	150 PSI	25%
280 SERIES	150 PSI	30%
325 SERIES	150 PSI	33%
330 IG SERIES	150 PSI	100%
350 SERIES	150 PSI	100%
380 SERIES	200 PSI	100%
		55% @ 200 PSI
400 SERIES	150 PSI	33%
420 SERIES	150 PSI	33%
425 SERIES	175 PSI	33% @ 175 PSI
		50%
444 SERIES	200 PSI	100%
		50% @ 200 PSI
450 SERIES	150 PSI	100%
450 IG SERIES	150 PSI	100%
460 SERIES	150 PSI	100%
480 SERIES	200 PSI	100%
		50% @ 200 PSI
485 SERIES	200 PSI	100%
		100% @ 200 PSI

ABOUT COMPRESSOR DUTY CYCLE:

Duty cycle refers to the amount of time a compressor can be operated in a given time period at 100 PSI, and a standard ambient temperature of 72° F. It is commonly expressed in percentage format: $\text{Compressor on time} \div (\text{on time} + \text{off time}) = \text{Duty Cycle \%}$.

ONE-HOUR DUTY CYCLE

(100 PSI @ 72°F)

9%
10%
15%
20%
25%
30%
33%
50%
100%

MINUTES ON / MINUTES OFF

5 Min. On / 55 Min. Off
6 Min. On / 54 Min. Off
9 Min. On / 51 Min. Off
12 Min. On / 48 Min. Off
15 Min. On / 45 Min. Off
18 Min. On / 42 Min. Off
20 Min. On / 40 Min. Off
30 Min. On / 30 Min. Off
1 Hour Run Time

ABOUT RATED WORKING PRESSURE:

To ensure trouble free service life of your compressor, always operate compressor within rated working pressure of the compressor. Never use a pressure switch with a higher cut-off pressure than compressor's rated working pressure.

ADVENTURE SERIES TOYHAULER DUAL ONBOARD AIR SYSTEM

AMERICAN WIRE GAUGE GUIDE 12-VOLT:

Amp Draw	Length of wire from battery to compressor (in feet)			
	5	10	15	20
5	16	16	16	14
10	16	14	12	10
15	16	12	10	10
20	14	10	10	8
25	14	10	8	6
30	12	10	8	6
40	12	8	6	6
50	10	6	6	4
60	10	6	4	4

Wiring Diagram - Figure 3:
(Fuse not included)

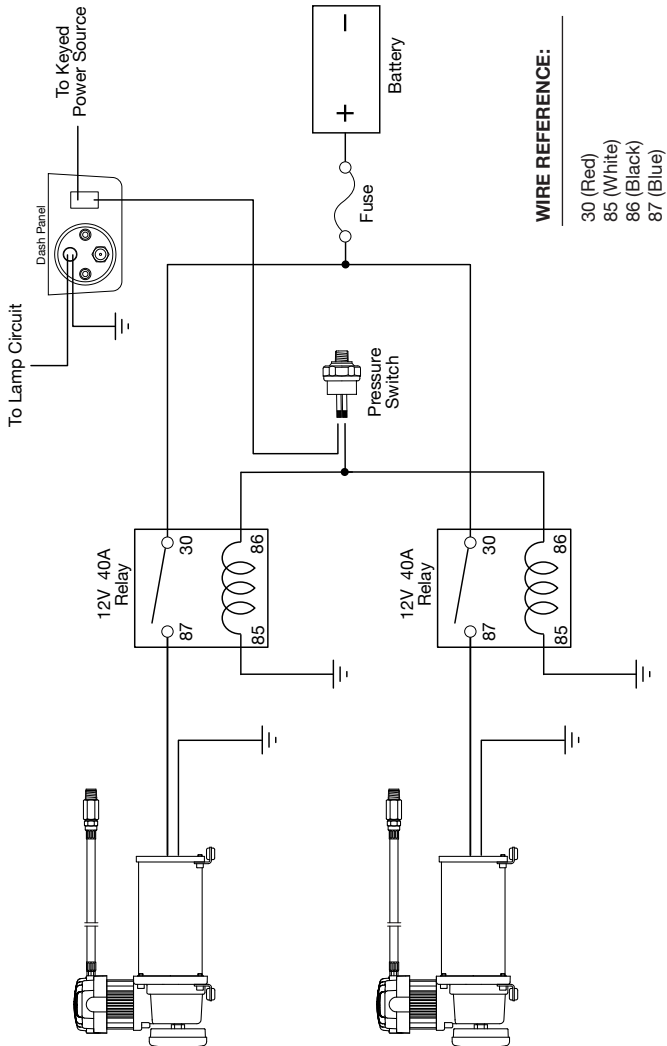

WIRE REFERENCE:

- 30 (Red)
- 85 (White)
- 86 (Black)
- 87 (Blue)

ADVENTURE SERIES TOYHAULER DUAL ONBOARD AIR SYSTEM

SPECIFICATIONS

- Part No. 50009 / Mobile Playground Constant OBA System (CE Certified, Compressor Only)

Motor Voltage:	12-Volts
Combined Max. Current Consumption:	46-Amps
Motor Type:	Permanent Magnetic
Horsepower:	1/4
Max. Working Pressure:	200 PSI
Max. Duty Cycle (@ 72°F & 100 PSI):	100%
Max. Duty Cycle (@ 72°F & 200 PSI):	55%
Minutes On/Off (@ 72°F & 100 PSI):	Continuous
Minutes On/Off (@ 72°F & 200 PSI):	33 Min. On / 27 Min. Off
Max. Restart Pressure:	200 PSI
Max. Ambient Temperature:	158°F
Min. Ambient Temperature:	-40°F
Auto. Reset Thermal Protection:	Yes
Ingress Protection Rating:	IP67

- Part No. 50011 / Stealth Player Heavy Duty OBA System (CE Certified, Compressor Only)

Motor Voltage:	12-Volts
Combined Max. Current Consumption:	60-Amps
Motor Type:	Permanent Magnetic
Horsepower:	1/4
Max. Working Pressure:	150 PSI
Max. Duty Cycle (@ 72°F & 100 PSI):	33%
Minutes On/Off (@ 72°F & 200 PSI):	20 Min. On / 40 Min. Off
Max. Restart Pressure:	150 PSI
Max. Ambient Temperature:	158°F
Min. Ambient Temperature:	-40°F
Auto. Reset Thermal Protection:	Yes
Ingress Protection Rating:	IP67

- Part No. 50013 / Road Warrior Constant OBA System (CE Certified, Compressor Only)

Motor Voltage:	12-Volts
Combined Max. Current Consumption:	46-Amps
Motor Type:	Permanent Magnetic
Horsepower:	1/4
Max. Working Pressure:	200 PSI
Max. Duty Cycle (@ 72°F & 100 PSI):	100%
Max. Duty Cycle (@ 72°F & 200 PSI):	50%
Minutes On/Off (@ 72°F & 100 PSI):	Continuous
Minutes On/Off (@ 72°F & 200 PSI):	30 Min. On / 30 Min. Off.
Max. Restart Pressure:	150 PSI
Max. Ambient Temperature:	158°F
Min. Ambient Temperature:	-40°F
Auto. Reset Thermal Protection:	Yes
Ingress Protection Rating:	IP67

ADVENTURE SERIES TOYHAULER DUAL ONBOARD AIR SYSTEM

This page intentionally left blank .

ADVENTURE SERIES TOYHAULER DUAL ONBOARD AIR SYSTEM

LIMITED WARRANTY:

VIAIR® Corporation warrants this product, when properly installed and under normal conditions of use, to be free from defects in workmanship and materials for a period of one year from its original date of purchase. To receive warranty service or repair, please contact VIAIR® Corporation.

Returns should be made within one year of the date of purchase, after a Return Goods Authorization (RGA) number has been assigned by VIAIR® Corporation. To obtain RGA, fax a copy of your receipt to (949) 585-0188. For complete warranty details, please visit: www.viaircorp.com/warranty

PLEASE NOTE:

THIS WARRANTY COVERS PRODUCT DEFECTS ONLY; IT DOES NOT COVER INCIDENTAL OR CONSEQUENTIAL DAMAGES AS RESULT OF MISUSE OR ABUSE.

This Manual is proprietary to VIAIR® Corporation and no ownership rights are hereby transferred. No part of the Manual shall be used, reproduced, translated, converted, adapted, stored in a retrieval system, communicated or transmitted by any means, for any commercial purpose, including without limitation, sale, resale, license, rental or lease, without the prior express written consent of VIAIR®.

VIAIR® does not make any representations, warranties or guarantees, express or implied, as to the accuracy or completeness of the Manual. Users must be aware that updates and amendments will be made from time to time to the Manual. It is the user's responsibility to determine whether there have been any such updates or amendments. Neither VIAIR® nor any of its directors, officers, employees or agents shall be liable in contract, tort or in any other manner whatsoever to any person for any loss, damage, injury, liability, cost or expense of any nature, including without limitation incidental, special, direct or consequential damages arising out of or in connection with the use of the Manual.



15 EDELMAN • IRVINE, CA 92618
TEL: (949) 585-0011 • FAX: (949) 585-0188
www.viaircorp.com