

advanced FLOW engineering

Cold Air Intake System

Instruction Manual P/N: 56-10021D / 56-10021R

Make: Hyundai

Model: Veloster N

Year: 2019-2022

Engine: L4-2.0L(t)



- Please read the entire instruction manual before proceeding.
- Ensure all components listed are present.
- If you are missing any of the components, call customer support at 951-493-7185.
- Ensure you have all necessary tools before proceeding.
- Do not attempt to work on your vehicle when the engine is hot.
- Disconnect the negative battery terminal before proceeding.
- Retain factory parts for future use.

Label	Qty.	Description	Part Number
A1	1	Air Filter (Pro 5R)	24-91108
A2	1	Air Filter (Pro DRY S)	21-91108
B	1	Tube	05-5670021B1
C	1	Housing	05-5610021B2
D	1	Seal trim (27.5" Long)	05-01534
E	1	Coupling, Silicone Reducer	05-01333
F	1	Clamp, #044	03-50019
G	1	Clamp, #048	03-50007
H	1	Fitting, Aluminum 10mm	03-50641
I	1	Fitting, Aluminum 11mm	03-50615
J	2	Retainer Clips	05-01350

Installation will require the following tools:

8mm and 10mm socket, extension, ratchet, 16mm wrench, pliers and flat-head screwdriver

Warranty Information available at: <https://afepower.com/contact#warranty>

Emissions Disclaimer: This product is not currently CARB exempt and is not available for purchase in California or for use on any vehicle registered with the California Department of Motor Vehicles.

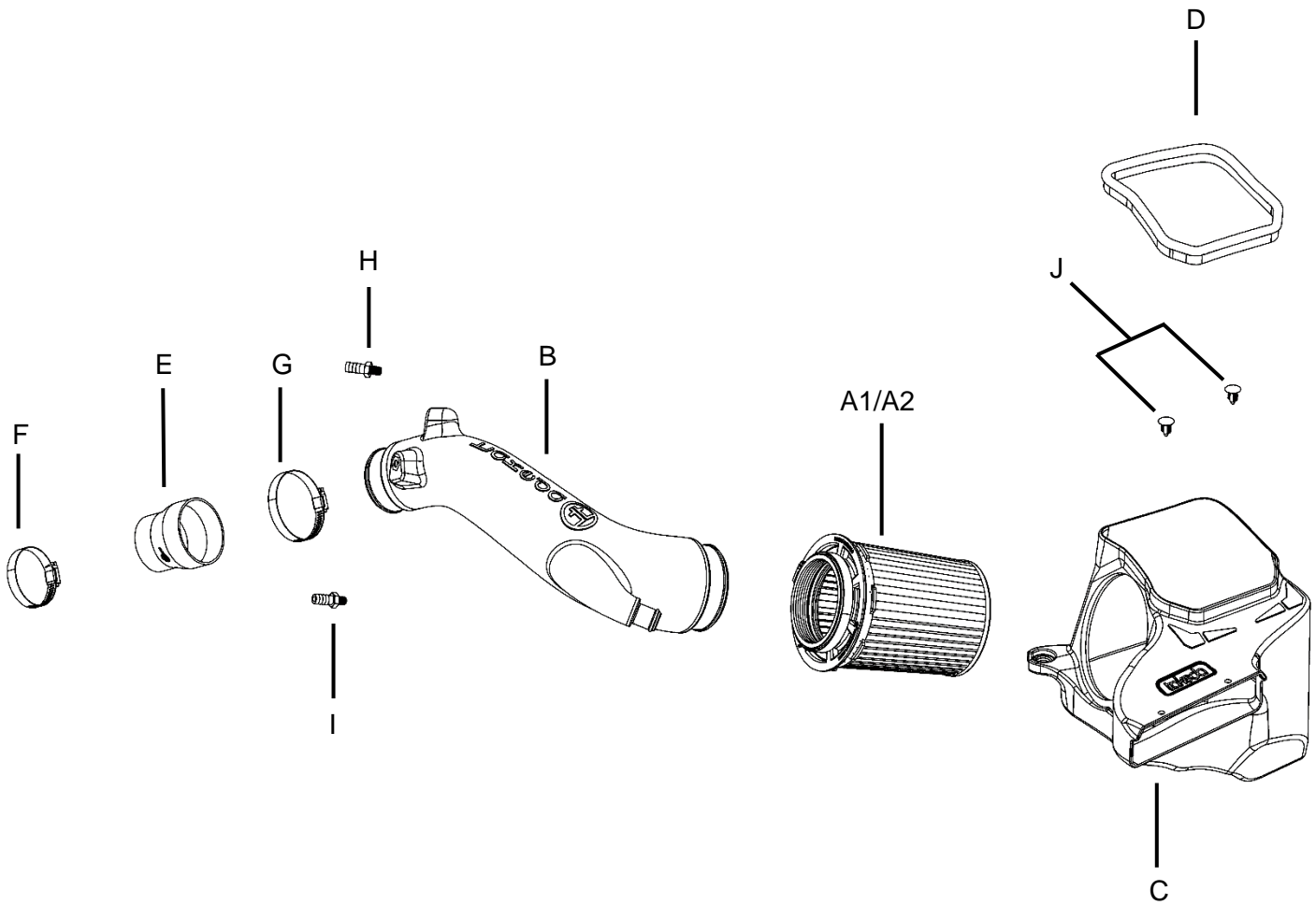

**Figure A**

Refer to Figure A for Steps 1-4

Step 1: Remove the engine cover by pulling upward on it.

Step 2: Using pliers, open the clamp securing the hose to the air intake tube, and then slide the clamp away from the intake tube. This clamp will be re-used. Disconnect the rubber hose from the air intake tube.

Step 3: Loosen the clamp securing the factory intake tube to the factory air box.

**Figure B****Refer to Figure B for Step 4-6**

Step 4: Using pliers, open the clamps securing the small hoses to the air intake tube toward the firewall.

Slide the clamps away from the tube and disconnect the small rubber hoses from the intake tube. Those clamps will be re-used.

Step 5: Loosen the clamp at the turbo inlet using a 10mm socket and ratchet.

Step 6: Remove the factory intake tube from the vehicle.

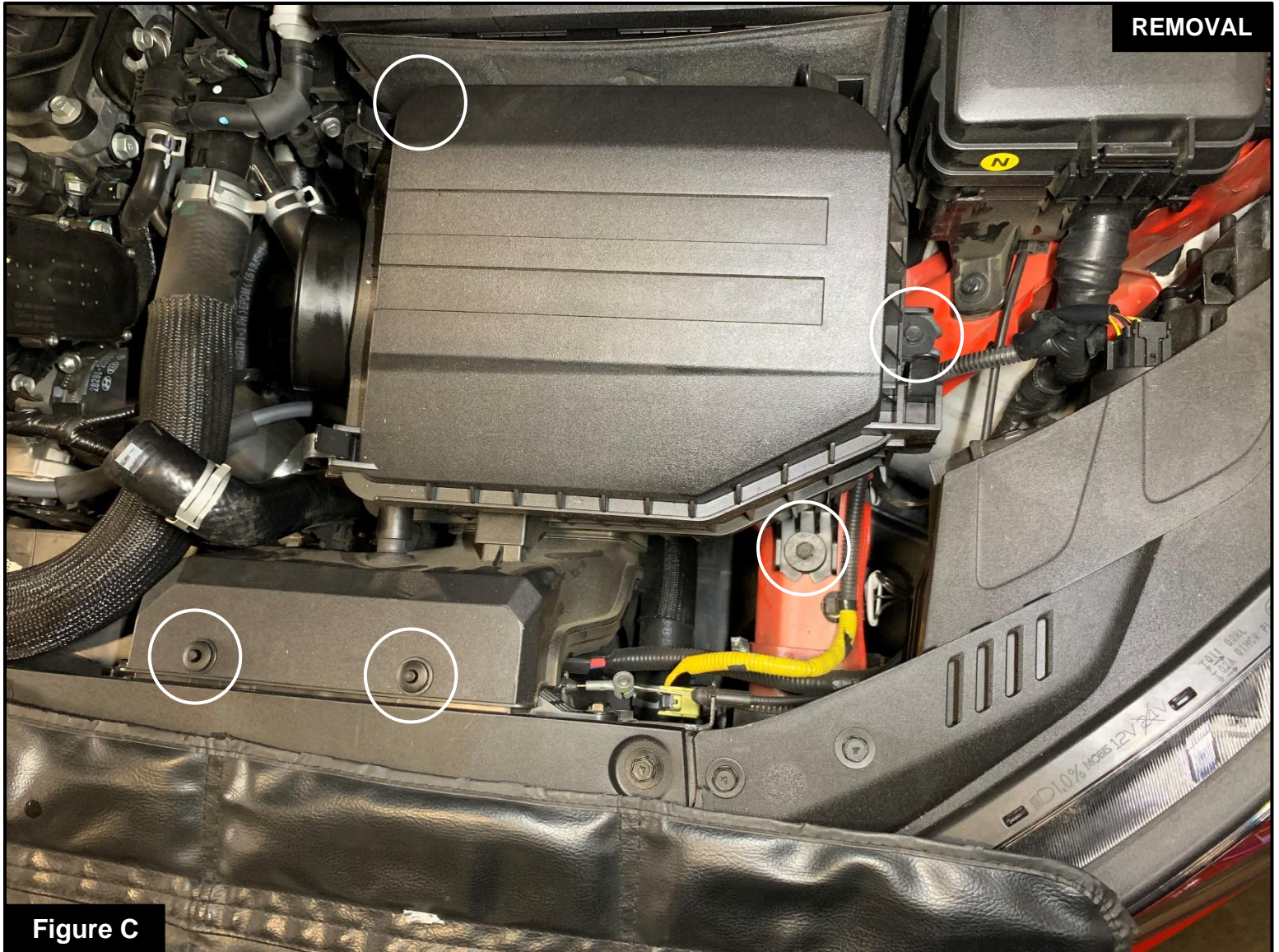

Figure C

Refer to Figure C for Steps 7-9

Step 7: Remove the two plastic rivets connecting the factory air inlet to the front of the car. Use a flat-head screwdriver to press down on the center of the rivet to unlock, and then pull them out. These plastic rivets will be replaced.

Step 8: With a 10mm socket, extension and ratchet, loosen the three bolts securing the factory housing to the vehicle. These three bolts will be re-used during the installation of the Takeda air intake system.

Step 9: Remove the bottom of the factory housing and air inlet as one piece out of the vehicle.



Figure D

Refer to Figure D for Step 10

Step 10: Transfer the three mounting grommets and sleeves from the bottom of the factory housing to the Takeda housing.



Figure E

Refer to Figure E for Step 11

Step 11: Install the provided seal trim around the top edges of the airbox.

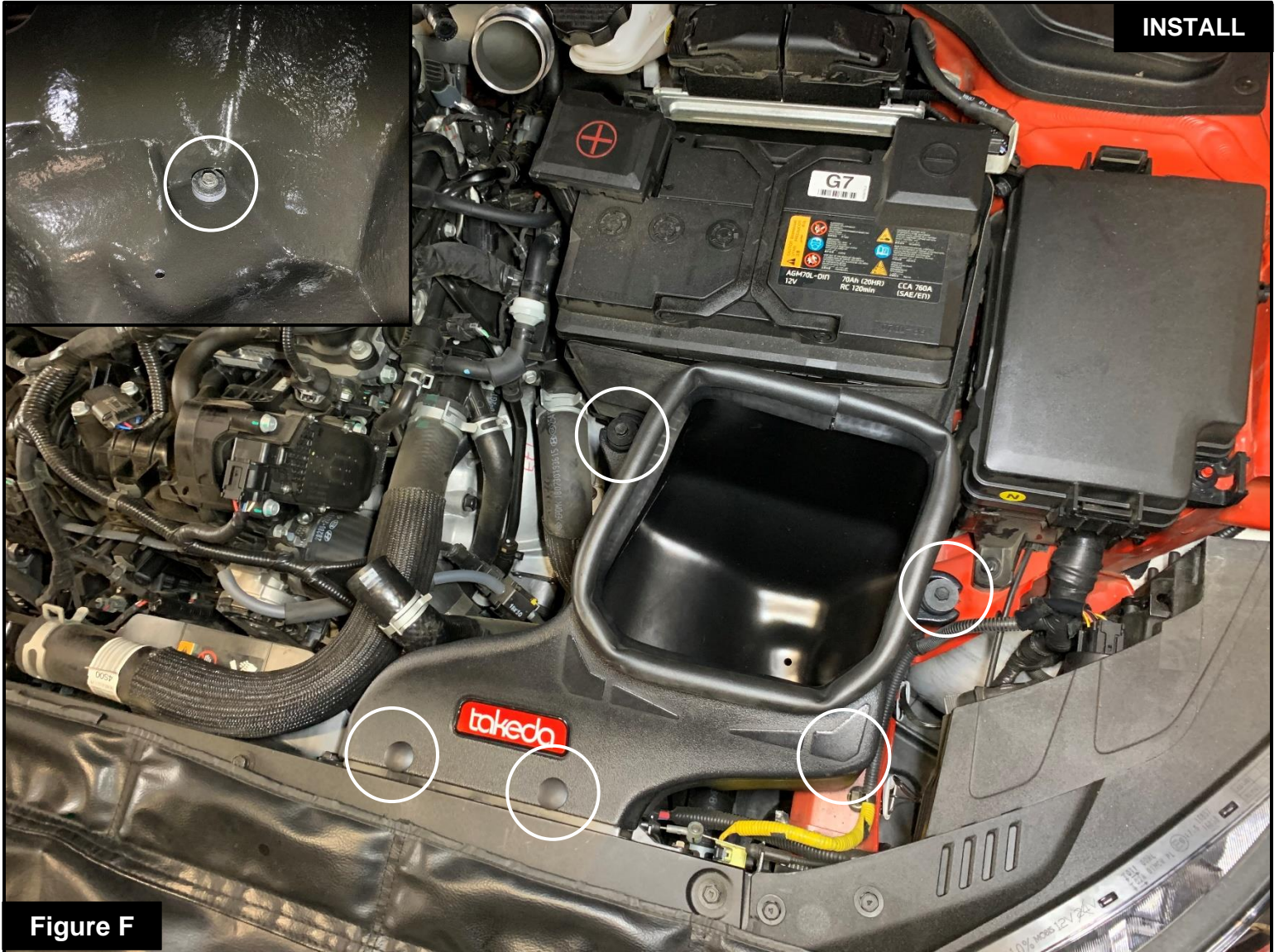
**Figure F****Refer to Figure F for Steps 12-13**

Step 12: Install the Takeda housing into the vehicle. Secure it with the three bolts removed at Step 8. One of the bolts will be installed inside the housing.

Step 13: Secure the housing to the air inlet with the two provided Christmas tree plastic rivets.



Refer to Figure G for Step 14

Step 14: Install the air filter into the housing by firmly pushing it into the round opening of the housing until the filter tabs lock it into place. Install on the clamp on the filter, but do not tighten at this time.

**Smaller fitting
(with three ribs)**



**Bigger fitting
(with four ribs)**

Figure H

Refer to Figure H for Step 15

Step 15: Using a 16mm wrench, install the aluminum fittings into the Takeda air intake tube. The two fittings are different. The bigger one (with four ribs) goes on the side of the tube. The smaller one (with three ribs) goes on the top of the tube.

Note: These are NPT fittings, the small gap between the 16mm hex and the tube is normal.

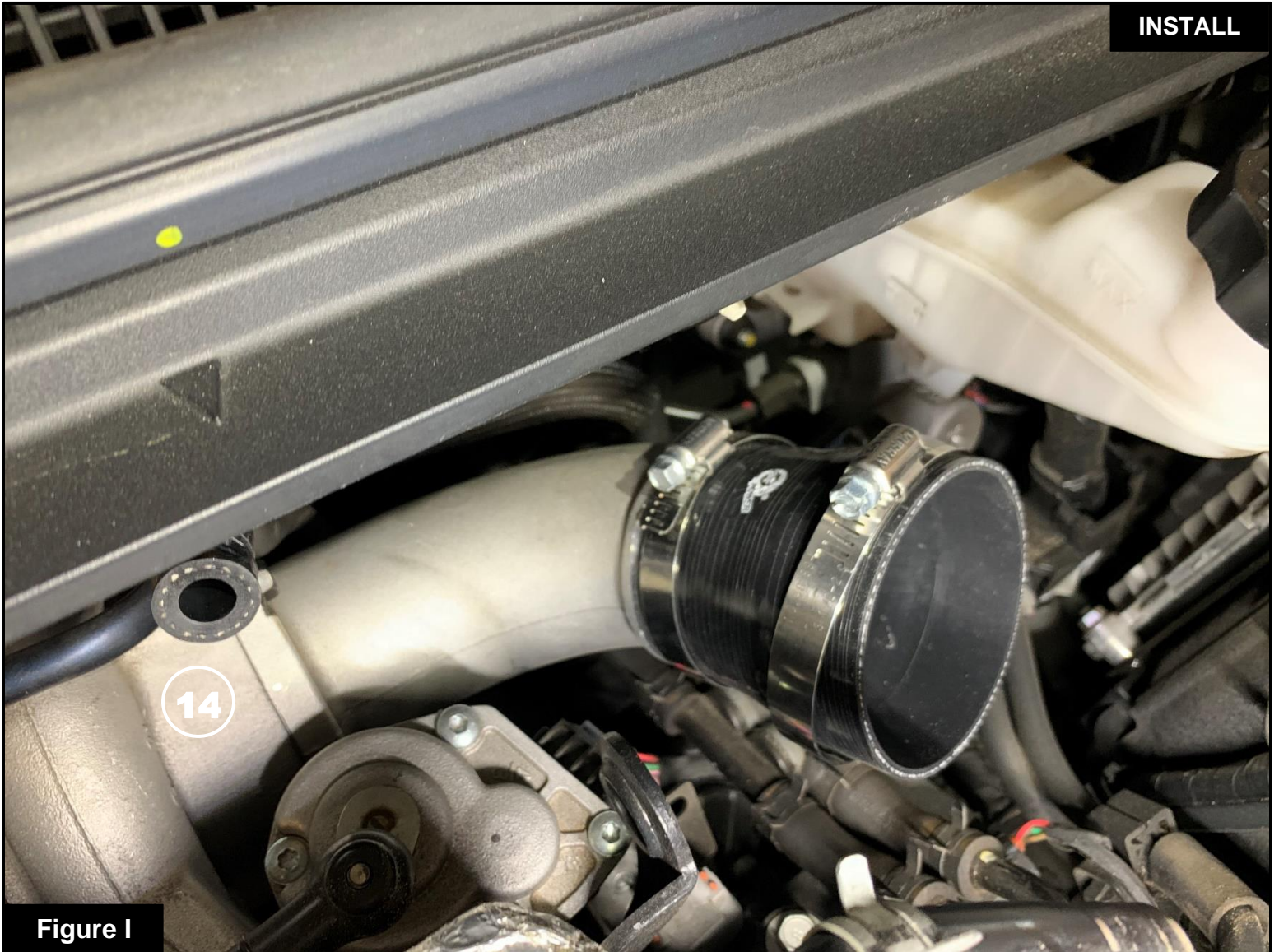
**Figure I****Refer to Figure I for Steps 16**

Step 16: Install the coupling onto the turbo inlet (the smaller end of the coupling goes onto the turbo inlet).
Install the provided clamps over the coupling, but do not tighten yet.

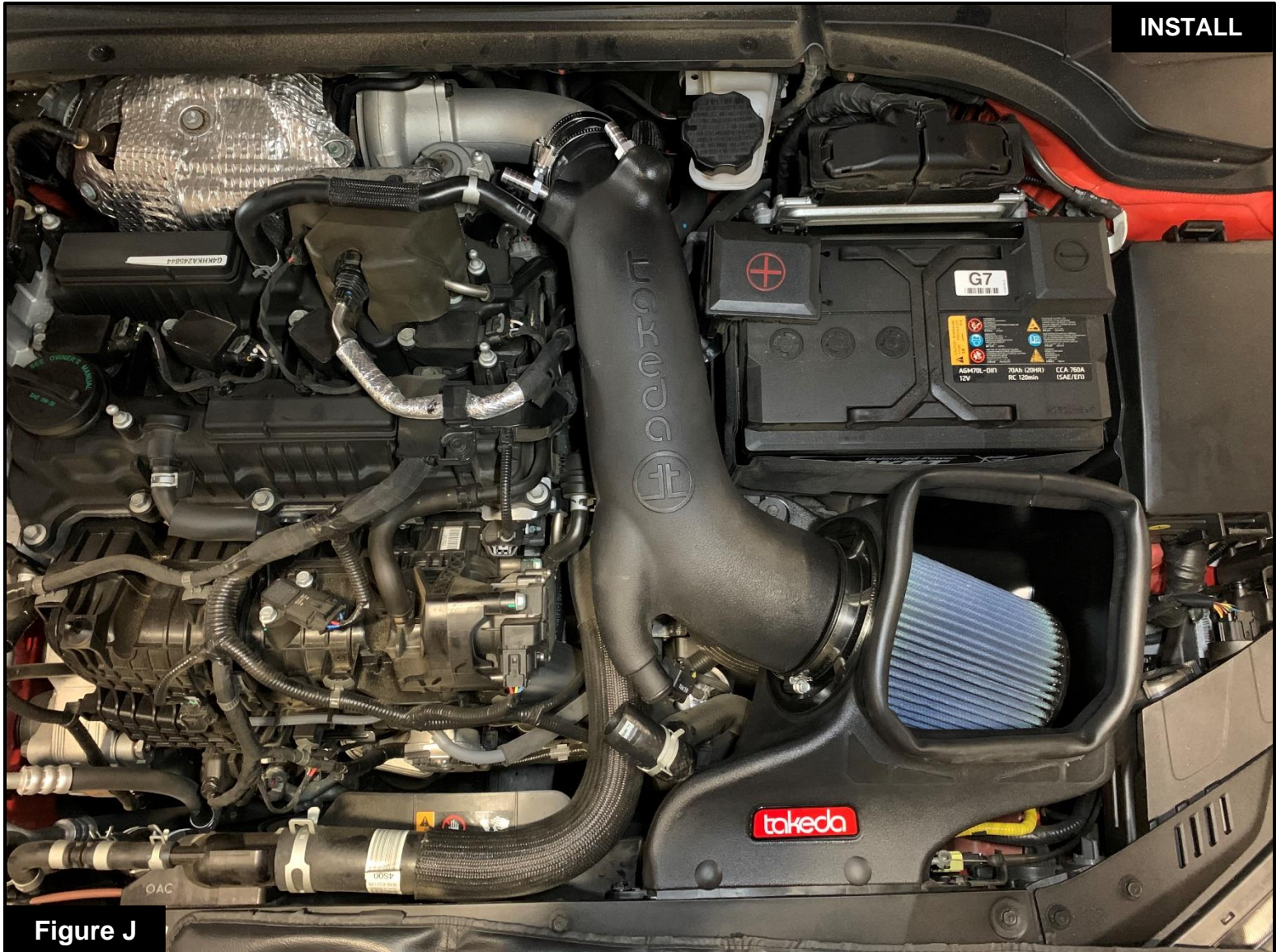

Refer to Figure J for Steps 17-18

Step 17: Install the Takeda intake tube by sliding it into the coupling then into the air filter.

Step 18: Align the tube, filter and coupling then tighten all clamps.

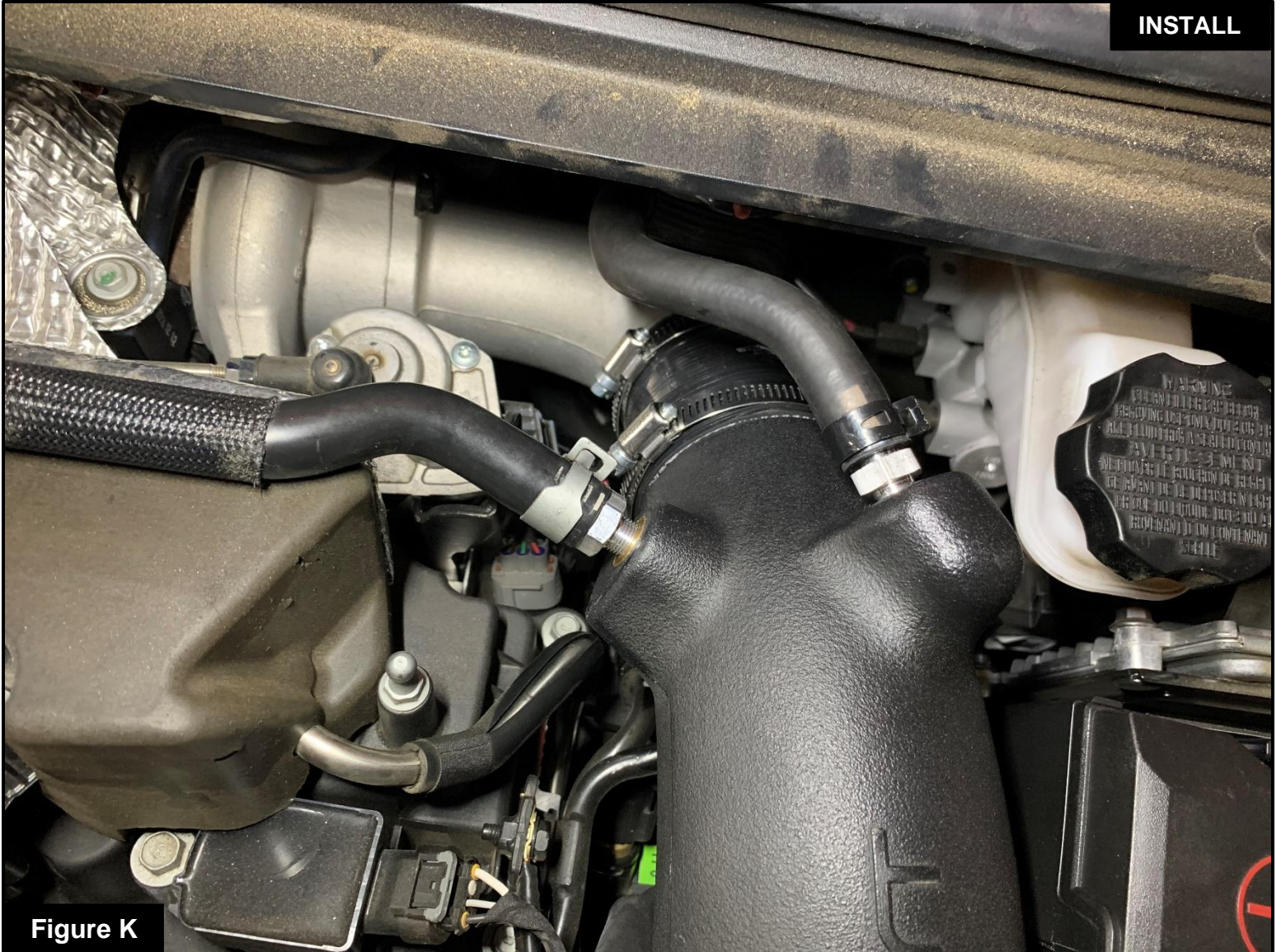
**Figure K****Refer to Figure K for Steps 19**

Step 19: Connect the small rubber hoses to the aluminum fitting on the tube. Secure them with the factory pry clamps.

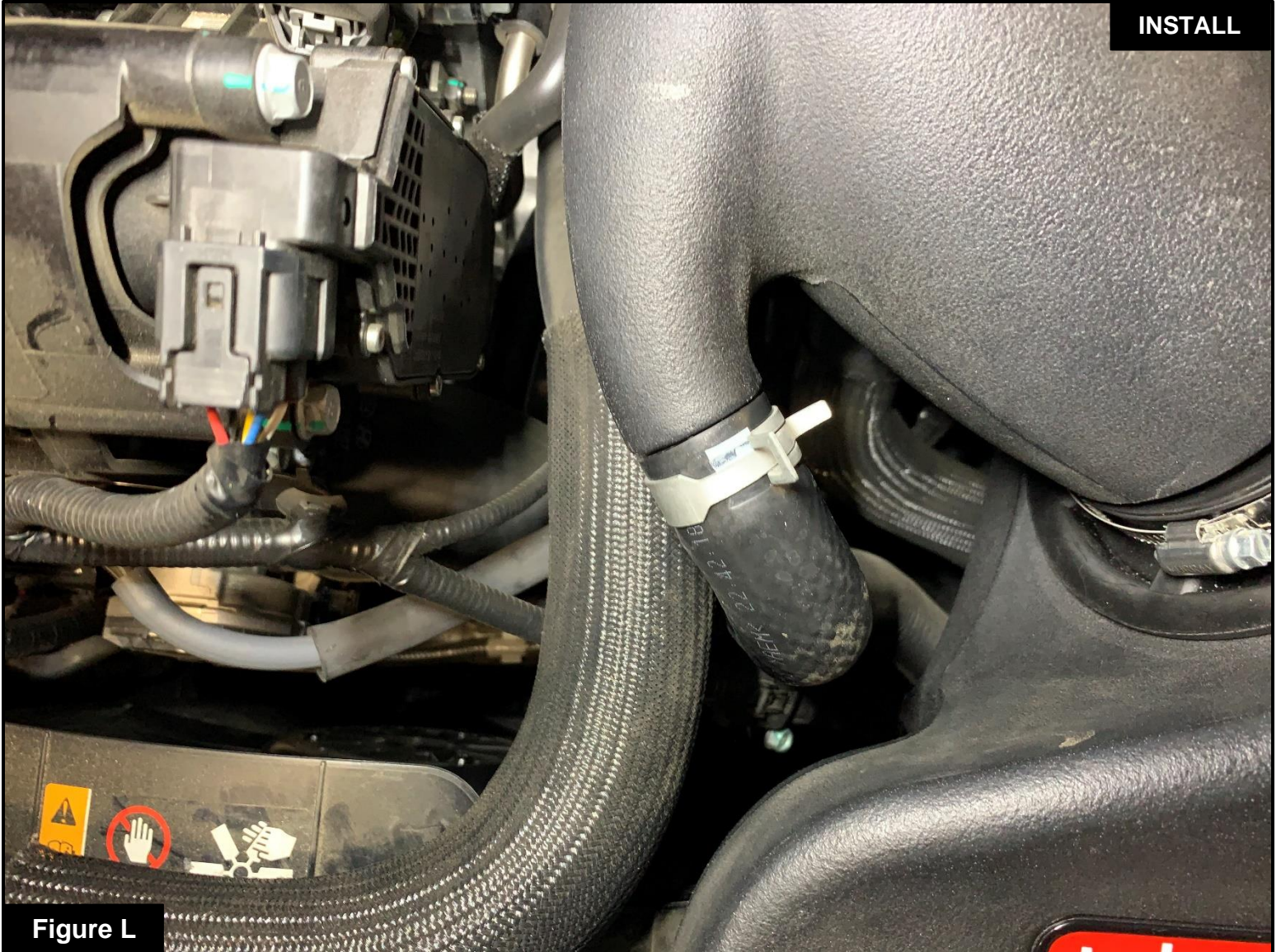
**Figure L****Refer to Figure L for Steps 20-21**

Step 20: Connect the bigger rubber hose to the Takeda air intake tube. Secure it with the factory pry clamp.

Step 21: Reinstall the engine cover.



Refer to Figure M for Steps 22

Step 22: Make sure all clamps and connections are secured. Your installation is now complete. Thank you for choosing Takeda USA!

NOTE: Check all screws, clamps, and connectors are secure after 100-200 miles.



Page left blank intentionally



Page left blank intentionally



Page left blank intentionally



advanced FLOW engineering, inc.

252 Granite Street Corona, CA 92879

<https://afepower.com/contact>