

advanced FLOW engineering Momentum HD Cold Air Intake System

Instruction Manual P/N: 50-70051D / 50-70051T

Make: RAM

Model: 2500

Year: 2019-2023

Engine: L6-6.7L(td) Cummins

Make: RAM

Model: 3500

Year: 2019-2023

Engine: L6-6.7L(td) Cummins



- Please read the entire instruction manual before proceeding.
- Ensure all components listed are present.
- If you are missing any of the components, call customer support at 951-493-7185.
- Ensure you have all necessary tools before proceeding.
- Do not attempt to work on your vehicle when the engine is hot.
- Retain factory parts for future use.

Label	Qty.	Description	Part Number
A1	1	Air Filter (Pro 10R) For 50-70051T	20-91147
A2	1	Air Filter (Pro DRY S) For 50-70051D	21-91147
B	1	Tube	05-5070051B1
C	1	Housing	05-5070051B2
D	1	Coupling, Silicone Bellow Reducer	05-01521
E	1	Clamp, T-bolt (4-1/16" - 4-3/8")	03-50262
F	1	Clamp, T-bolt (4-5/16"-4-5/8")	03-50499
G	1	Clamp, T-bolt (8-5/16" - 8-5/8")	03-50267
H	3	Screw, Torx: M4	03-50490
I	1	Plug Silicone	05-01429

Installation will require the following tools:

8mm & 10mm nut drivers or ratchet and sockets, T20 torx bit or driver, pliers or flat-head screwdriver

Warranty Information available at: <https://afepower.com/contact#warranty>

Emissions Disclaimer: This product is not currently CARB exempt and is not available for purchase in California or for use on any vehicle registered with the California Department of Motor Vehicles.

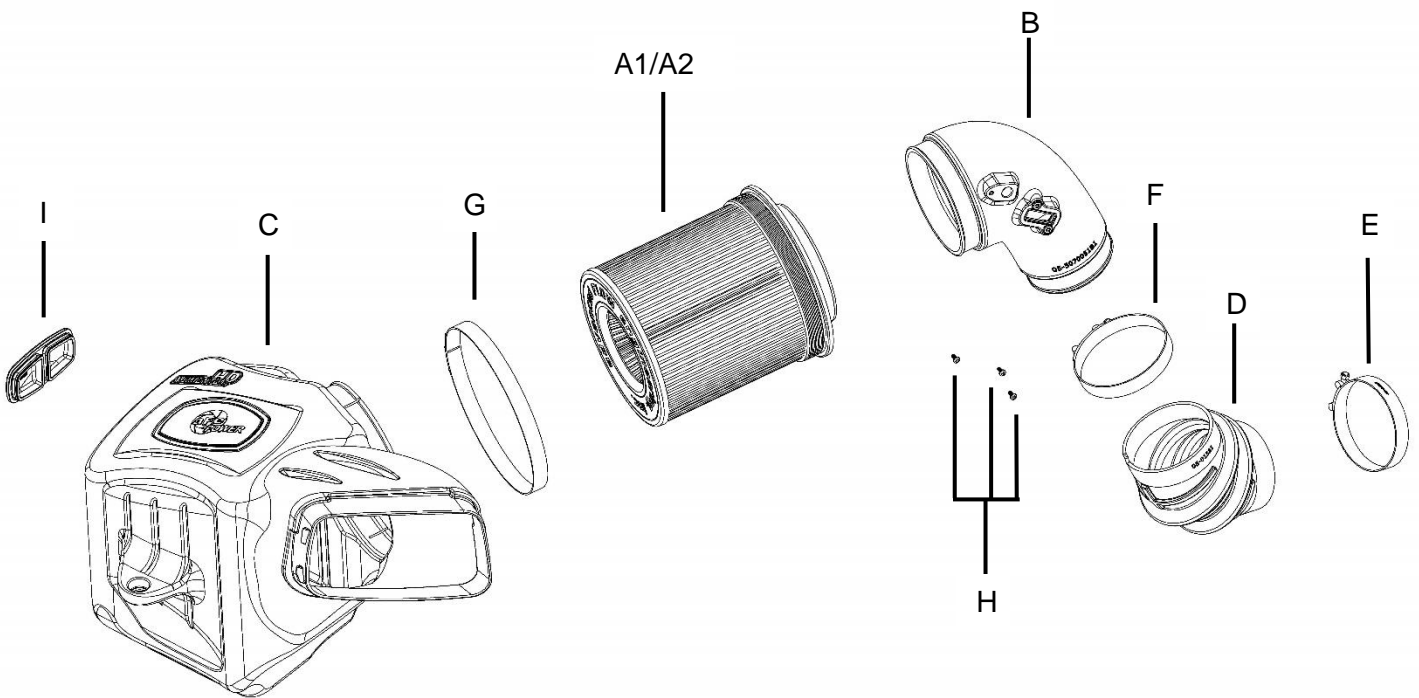

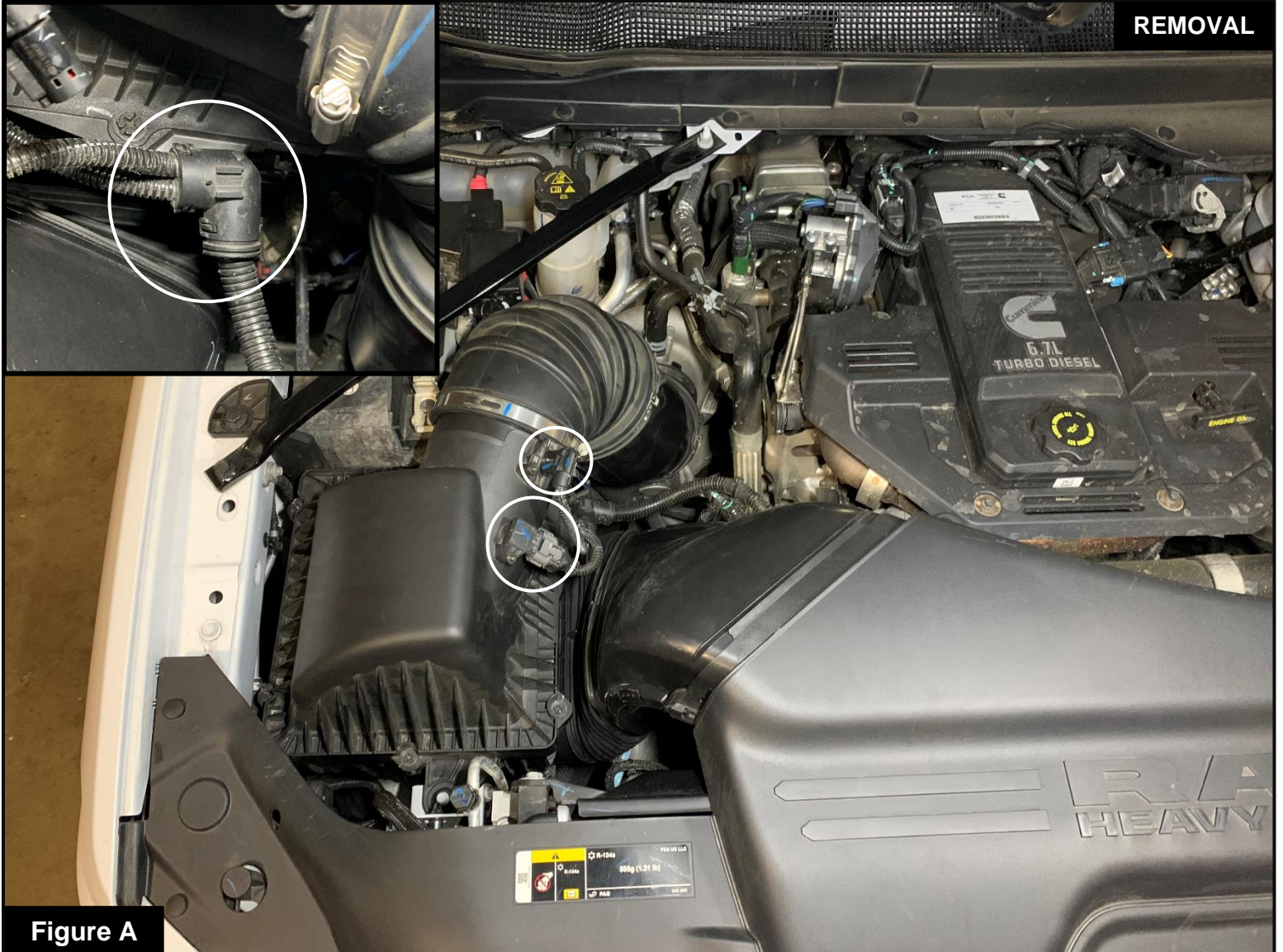

Figure A

Refer to Figure A for Steps 1-2

Step 1: After making sure your vehicle is completely off and in sleep mode, disconnect the Mass Air Flow (MAF) Sensor and Temperature sensor.

Step 2: Unclip the harness from the factory air box.



Figure B

Refer to Figure B for Steps 3-4

Step 3: Untighten the clamps securing the factory tube to the air box and the turbo.

Step 4: Disconnect the tube from the factory air box, then from the turbo. Take the factory tube out of the vehicle.

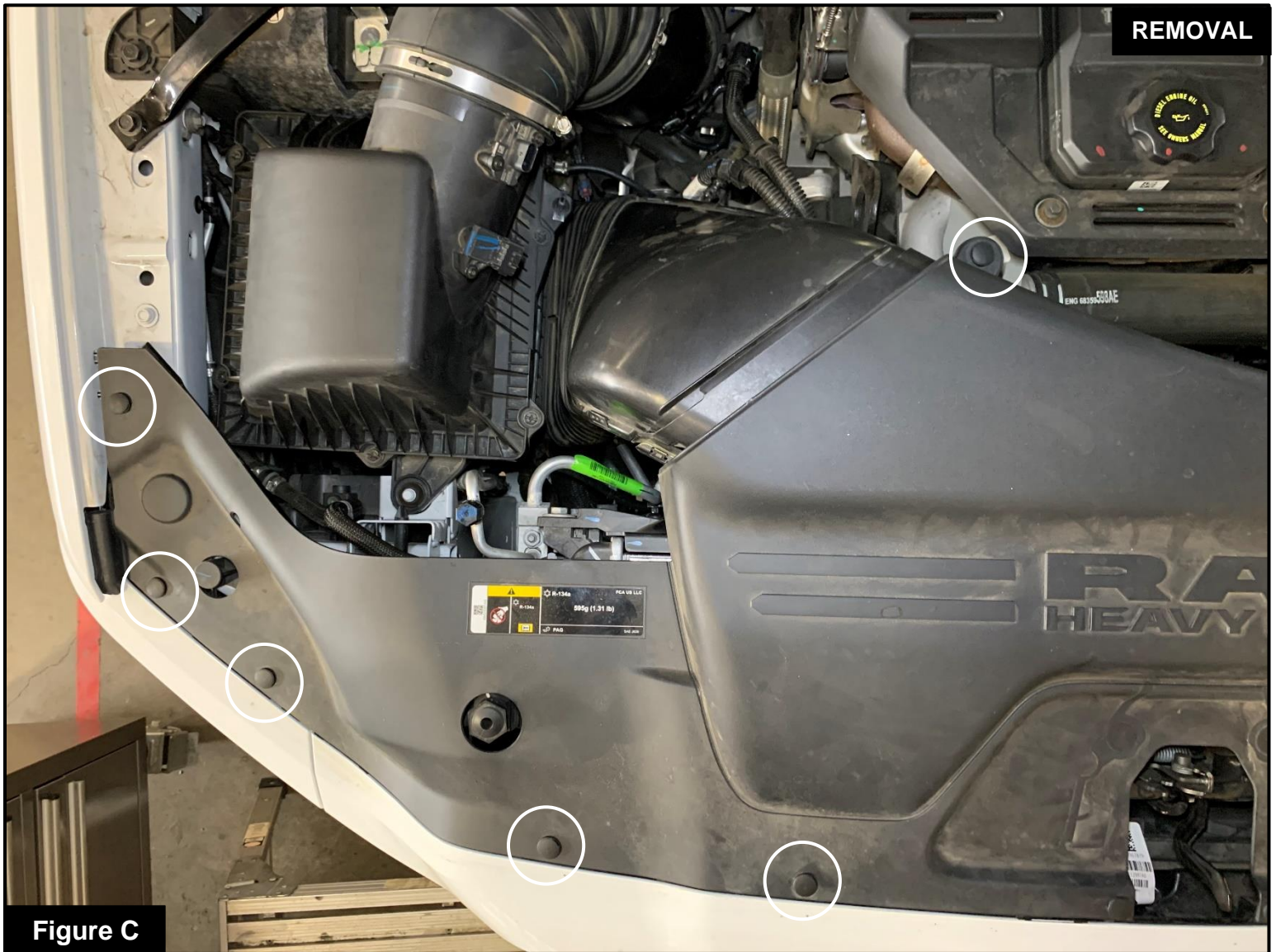
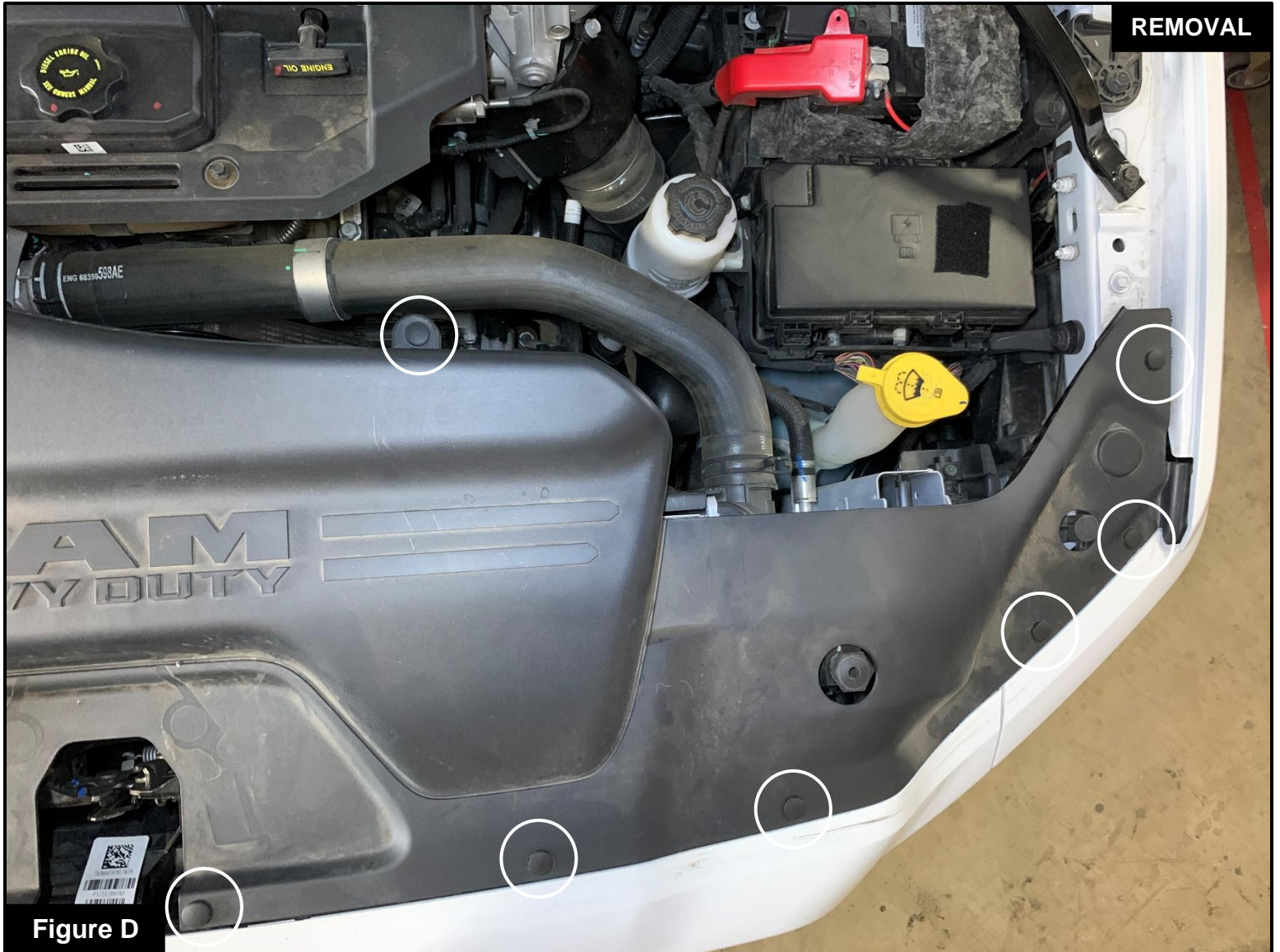

Figure C

Refer to Figure C for Step 5

Step 5: Using a flat head screw driver, or panel popper, remove the plastic rivets securing the front cover (circled).



REMOVAL

Figure D

Refer to Figure D for Steps 6-7

Step 6: Remove all plastic rivets securing the front cover (circled).

Step 7: Remove the front cover out of the vehicle to get access to the air inlet scoop.

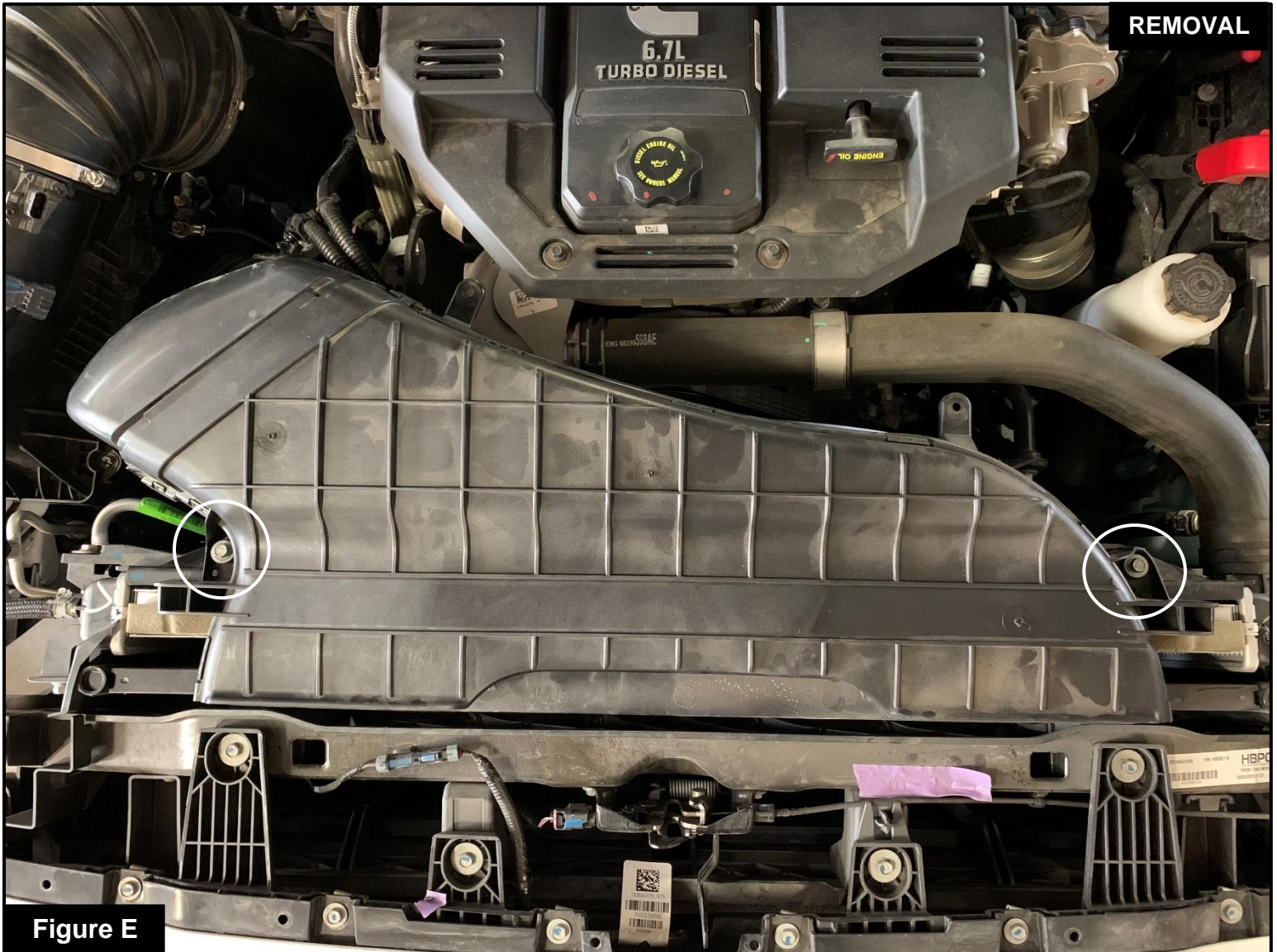

Refer to Figure E for Steps 8-9

Step 8: Remove the two screws (circled) securing the factory air intake scoop. These screws will be re-used.

Step 9: Pull the factory air box out of its mounting pegs, then carefully pull the factory airbox and scoop together out of the vehicle.



Figure F

Refer to Figure F for Step 10

Step 10: Transfer the three factory grommets from the factory air box to the aFe POWER housing.

**Figure G****Refer to Figure G for Steps 11-14**

- Step 11: Remove the factory scoop from the factory air box and connect it to the aFe POWER housing.
- Step 12: Slide the aFe POWER air filter into the housing.
- Step 13: Install the larger clamp on the aFe POWER housing and tighten it to secure the air filter.
- Step 14: Place the clamp supplied with the aFe POWER air filter over its flange. Do not tighten at this time.

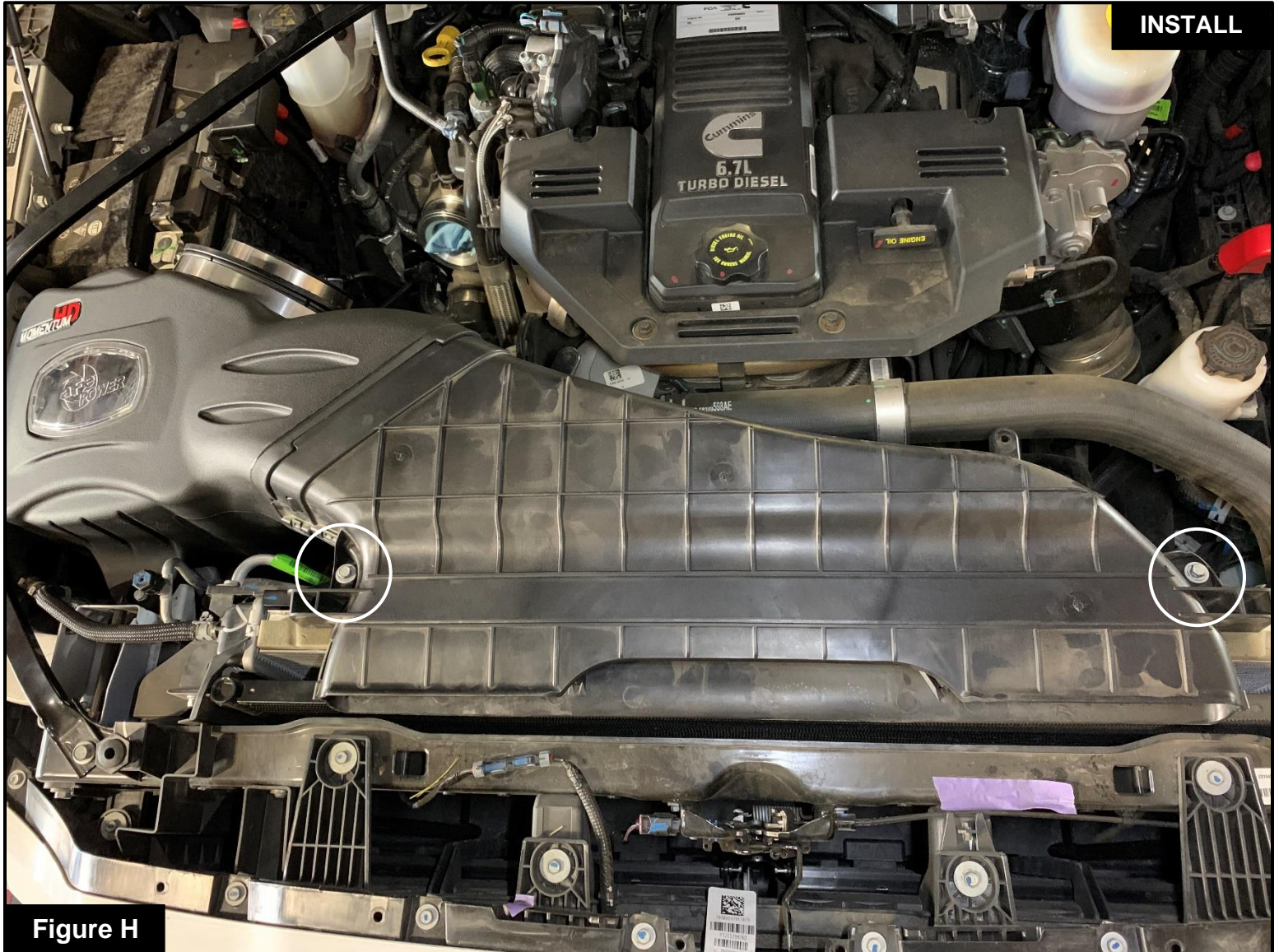

Figure H

Refer to Figure H for Steps 15-16

Step 15: Install the aFe POWER housing and factory scoop assembly into the vehicle. Press the housing into the mounting pegs.

Step 16: Secure the scoop using the two factory screws removed at step 8.

**Figure I****Refer to Figure I for Step 17**

Step 17: Transfer the MAF sensor and Temperature sensor from the factory air box to the aFe POWER tube. Secure them using the provided Torx Screws.

**Figure J****Refer to Figure J for Steps 18-19**

Step 18: Install the coupling onto the aFe POWER tube. Line up the notch on the coupling with the tube.

Step 19: Install the provided clamps over the coupling. Place the larger of the two to join the coupling and aFe POWER tube. Tighten the clamp on the tube side but do not tighten the clamp on the other end yet.



Figure K

Refer to Figure K for Steps 20-21

Step 20: Install the aFe POWER tube assembly over the turbo, then into the air filter.

Step 21: Align the tube correctly, then tighten all clamps.



Refer to Figure L for Step 22

Step 22: Reconnect the MAF and Temperature sensors harnesses.

 **Make sure that the connections are fully engaged. Usually, connectors make a snapping sound when fully engaged.**



Refer to Figure M for Step 23

Step 23: The kit includes an optional plug to close off the side auxiliary air inlet. Install the plug if you wish to close off the side auxiliary air inlet and only capture cold air from the front.

- Without the plug installed, the Momentum air intake will capture the maximum air available. More airflow offers more power. Yet some of this air is picked up from inside the engine compartment and could be warmer air. Warmer air will affect the performance of the vehicle.
- The plug installed on the housing will block off any hot engine air entering the housing and make sure the coolest air available is directed into the engine. It will also reduce the noise of the intake.



Figure N

Refer to Figure N for Steps 24-25

Step 24: Re-install the factory front cover and secure it with the plastic rivets removed at steps 5 and 6.

Step 25: Verify all clamps and connections are secured. Your installation is now complete. Thank you for choosing aFe POWER!

NOTE: Check all screws, clamps, and connectors are secure after 100-200 miles.



Page left blank intentionally



Page left blank intentionally

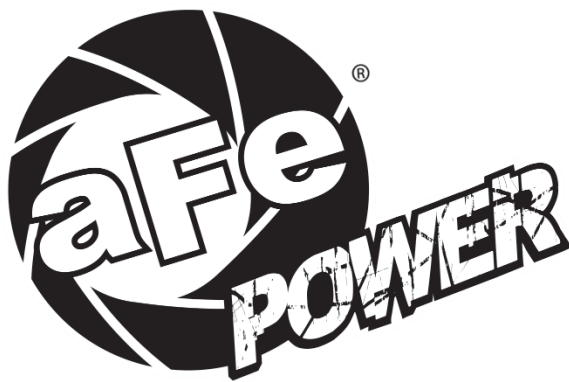

advanced FLOW engineering, inc.

252 Granite Street Corona, CA 92879

<https://afepower.com/contact>