

**advanced FLOW engineering** Momentum GT Cold Air Intake System

**Instruction Manual** P/N: 50-70077D / 50-70077R

Make: Nissan

Model: Frontier

Year: 2020-2024

Engine: V6-3.8L\*

\*Only fits vehicles without Idle Start/Stop feature equipped.



- Please read the entire instruction manual before proceeding.
- Ensure all components listed are present.
- If you are missing any of the components, call customer support at 951-493-7185.
- Ensure you have all necessary tools before proceeding.
- Do not attempt to work on your vehicle when the engine is hot.
- Retain factory parts for future use.

Label	Qty.	Description	Part Number
A1	1	Air Filter (Pro DRY S)	21-91062
A2	1	Air Filter (Pro 5R)	24-91062
B	1	Tube	05-5070077B1
C	1	Housing	05-76102B2
D	1	Coupling, Silicone	05-01358
E	1	Clamp, T-bolt (3-13/16" - 4-1/8") (SS)	03-50265
F	1	Clamp, T-bolt (3-9/16" - 3-7/8") (SS)	03-50498
G	1	Clamp, T-bolt (7-5/16"-7-5/8")	03-50290
H	1	Hose, 5/8" ID, 23" Length	05-01502
I	2	Spring Clamp	03-50646
J	1	Plug: Momentum HD	05-01202
K	2	Screw, M4	03-50491

**Installation will require the following tools:**

8mm and 10mm nut driver or socket, socket wrench, flat-head screwdriver, pliers, and panel popper.

Warranty information available at <https://afepower.com/contact#warranty>.

**Emissions Disclaimer:**

This product is not currently CARB exempt and is not available for purchase in California or for use on any vehicle registered with the California Department of Motor Vehicles.

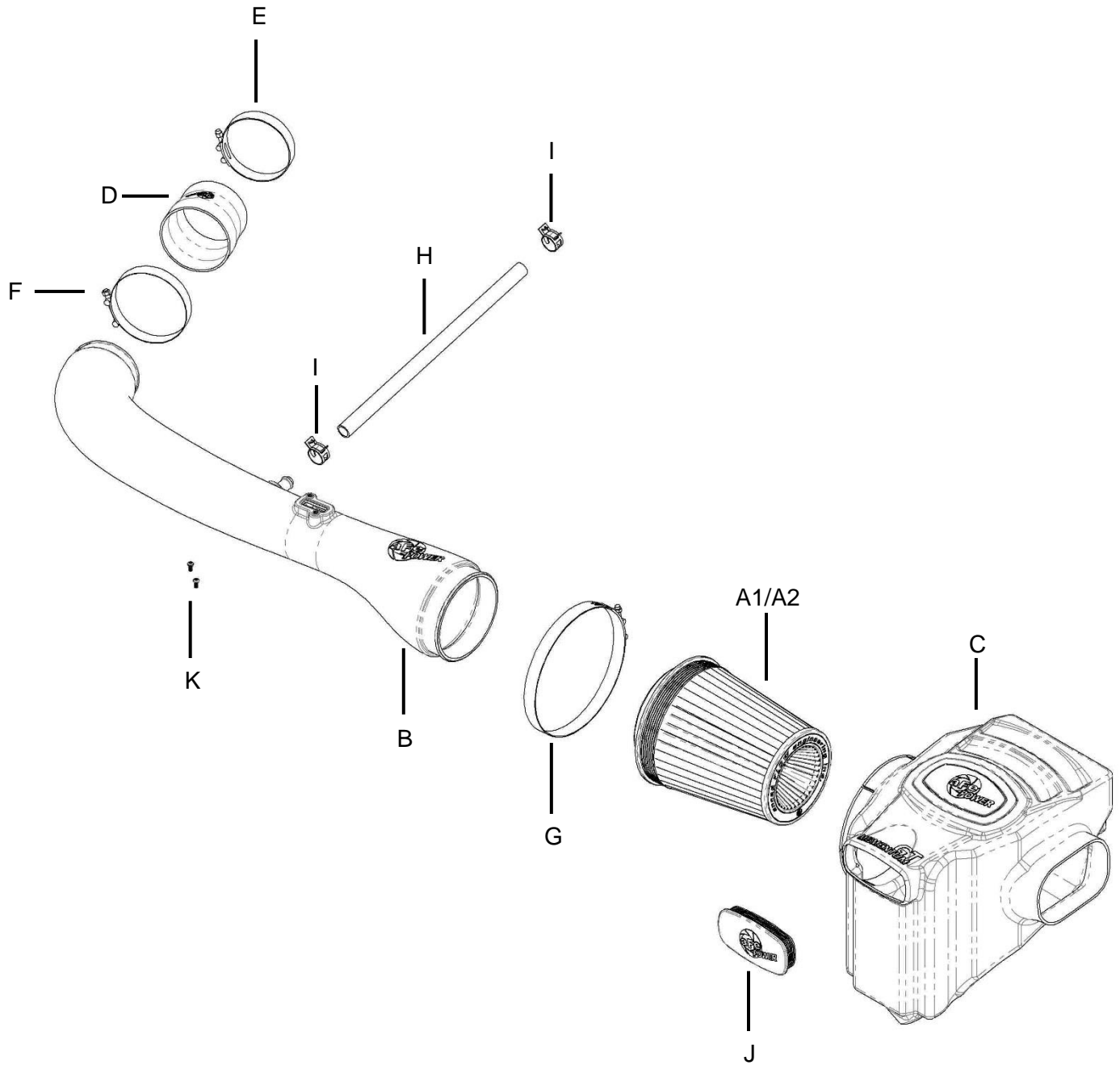

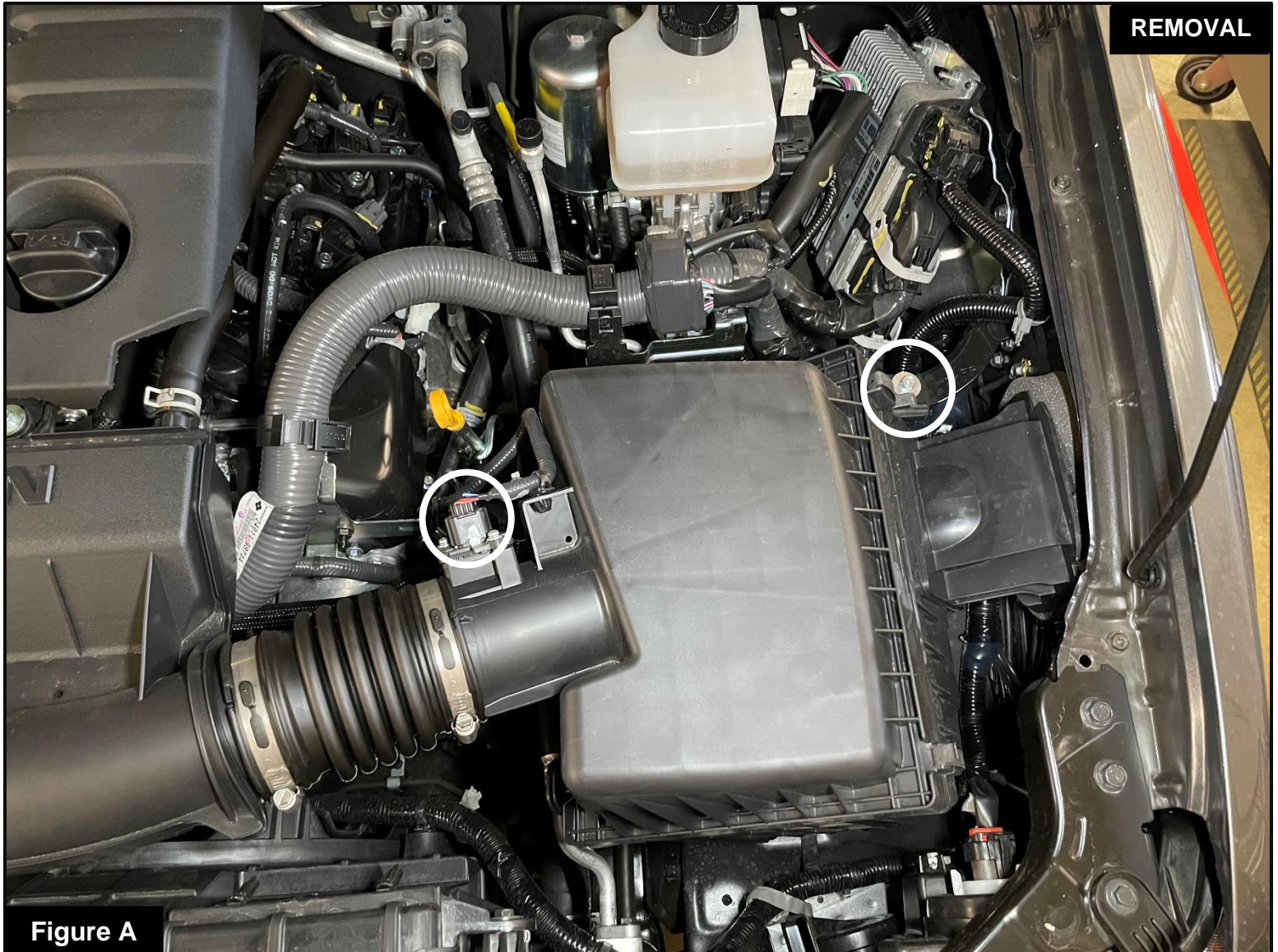

Figure A

**Refer to Figure A for Steps 1-2**

Step 1: Disconnect the mass air flow (MAF) sensor.

Step 2: Using a 10mm nut driver, remove the bolt securing the factory intake airbox to the vehicle. Keep the bolt for later use.

**IMPORTANT!** If there is a fuse box located between the air box and fender, then the vehicle is equipped with Idle Start/Stop and this intake will not fit! If your engine bay resembles **Figure A** above, then please proceed with the installation.

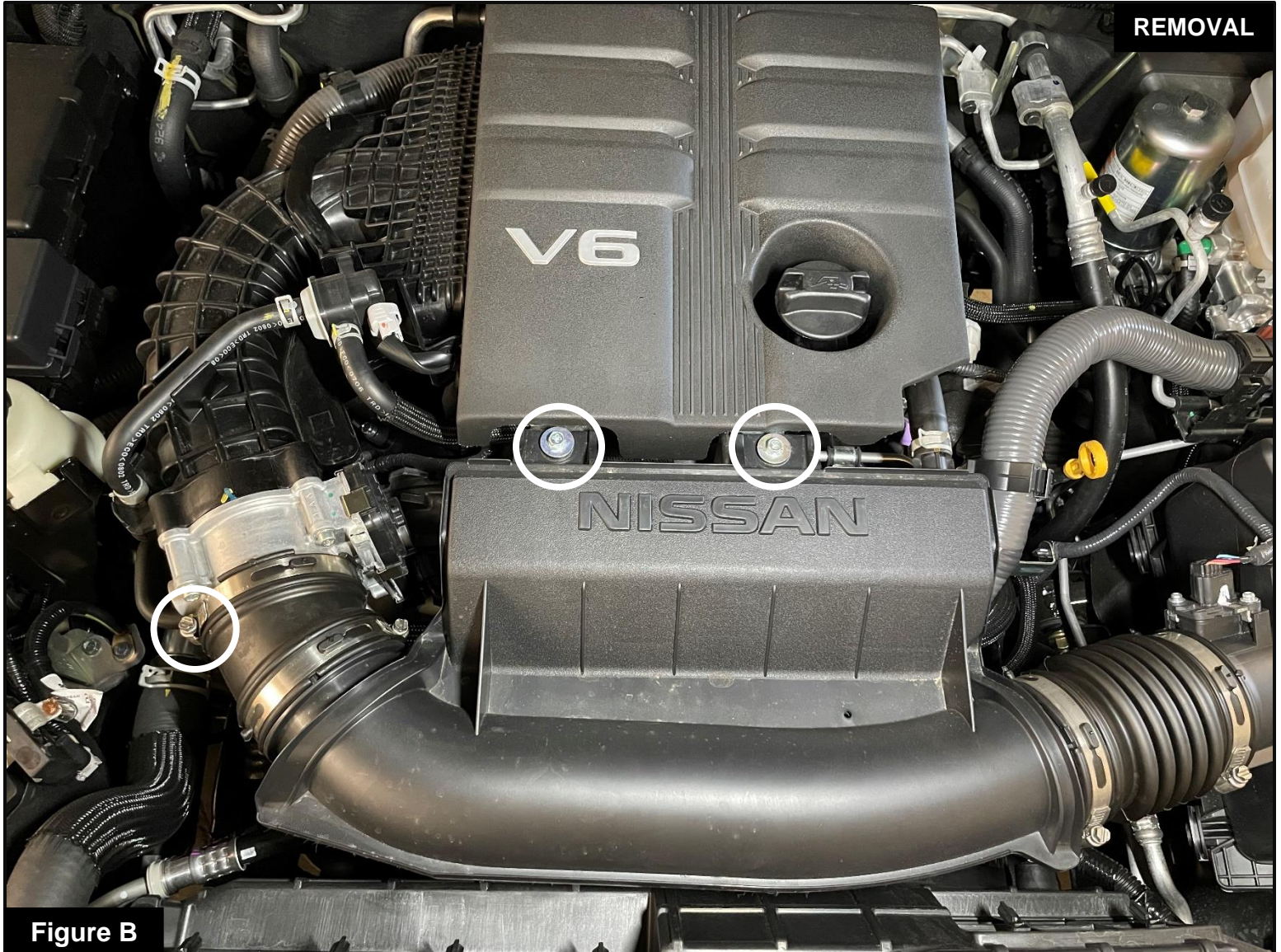

**Figure B**

**Refer to Figure B for Steps 3-5**

Step 3: Remove the engine cover.

Step 4: Loosen the two 10mm bolts mounting the factory intake tube to the engine.

Step 5: Using an 8mm nut driver, loosen the clamp at the throttle body.

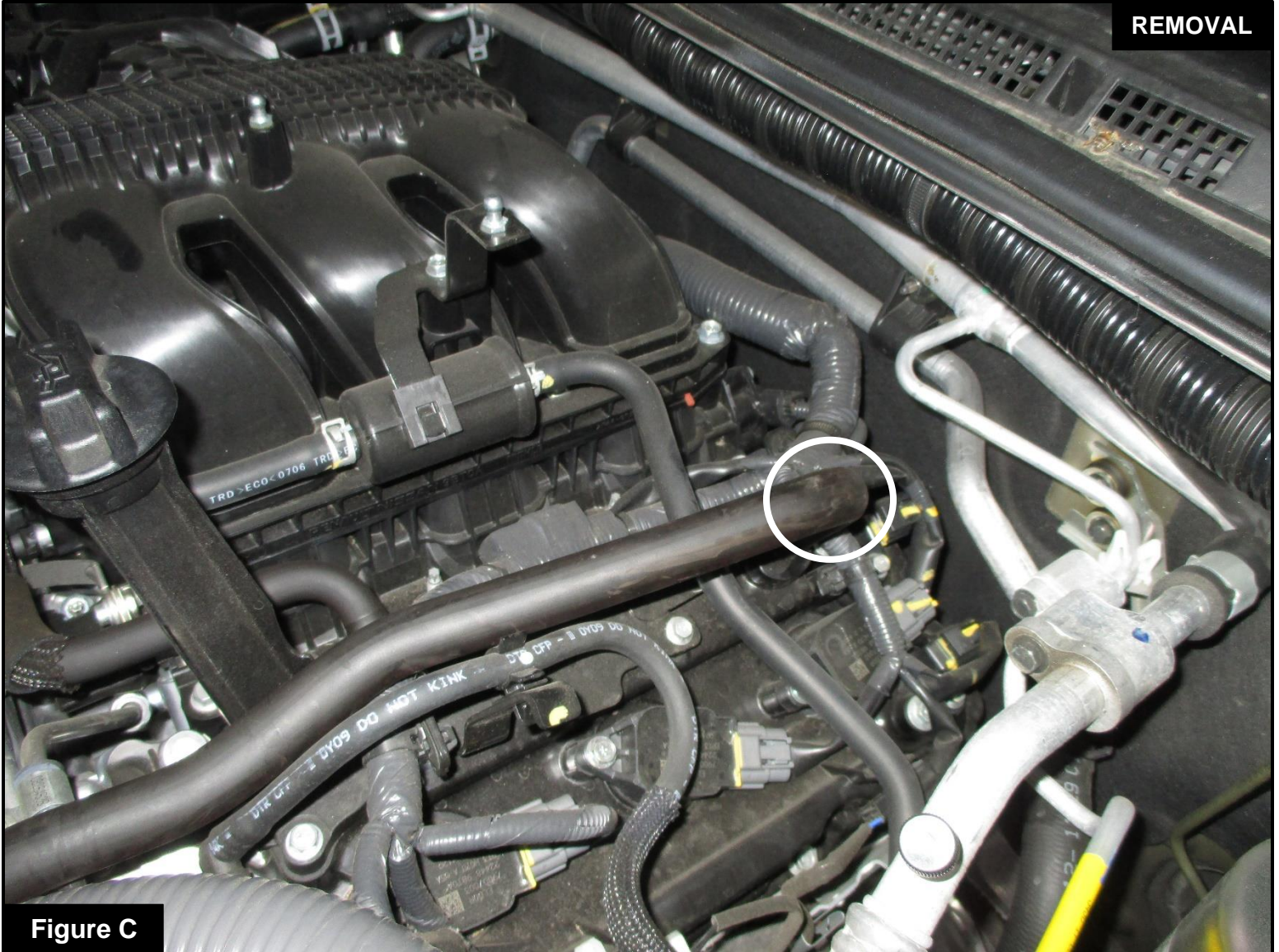
**Figure C****Refer to Figure C for Steps 6-7**

Step 6: Disconnect the crankcase vent (CCV) line from the engine.

Step 7: Remove the factory air intake. Carefully, pull the factory intake tube away from the throttle body and pull up on the factory airbox.

**Figure D****Refer to Figure D for Steps 8-9**

Step 8: Transfer the two (2) bottom factory grommets from the factory airbox to the aFe POWER housing.

Step 9: Transfer the remaining grommet and metal sleeve from the backside of the factory airbox to the aFe POWER housing.

**Figure E****Refer to Figure E for Step 10**

Step 10: This kit includes an optional plug to close off the front auxiliary air inlet. Install the plug if you wish to close off the inlet and only capture cold air from the fender opening.

Without the plug installed, the aFe POWER intake will capture the maximum air available. More air offers more power. Some of this air comes from inside of the engine compartment and could be warmer air.

Warmer air affects the performance of the vehicle.

With the plug installed, the aFe POWER intake will prevent hot air from entering the engine bay, making sure the coolest air available is directed into the engine. It will also reduce the noise of the intake.

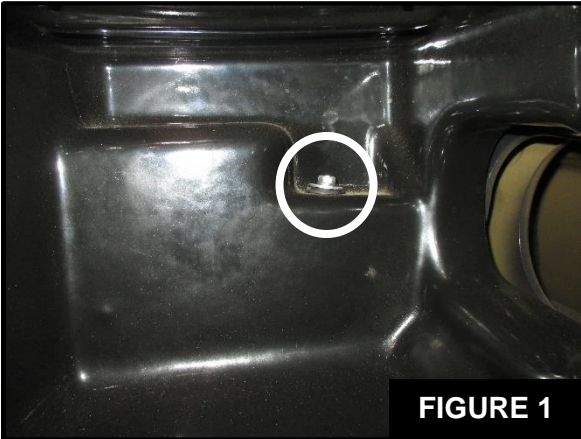

**FIGURE 1****Figure F**

### **Refer to Figure F for Steps 11-13**

Step 11: Press the aFe POWER housing into the vehicle and onto the two (2) mounting pegs.

Step 12: Install the bolt from Step 2 on the inside of the aFe POWER housing. Tighten the bolt.

Step 13: Place the largest supplied clamp over the flange of the aFe POWER housing. Do not tighten the clamp.



Figure G

**Refer to Figure G for Step 14**

Step 14: Install the supplied coupling and clamps onto the throttle body. Tighten the clamp at the throttle body, but do not tighten the clamp at the open end of the coupling.

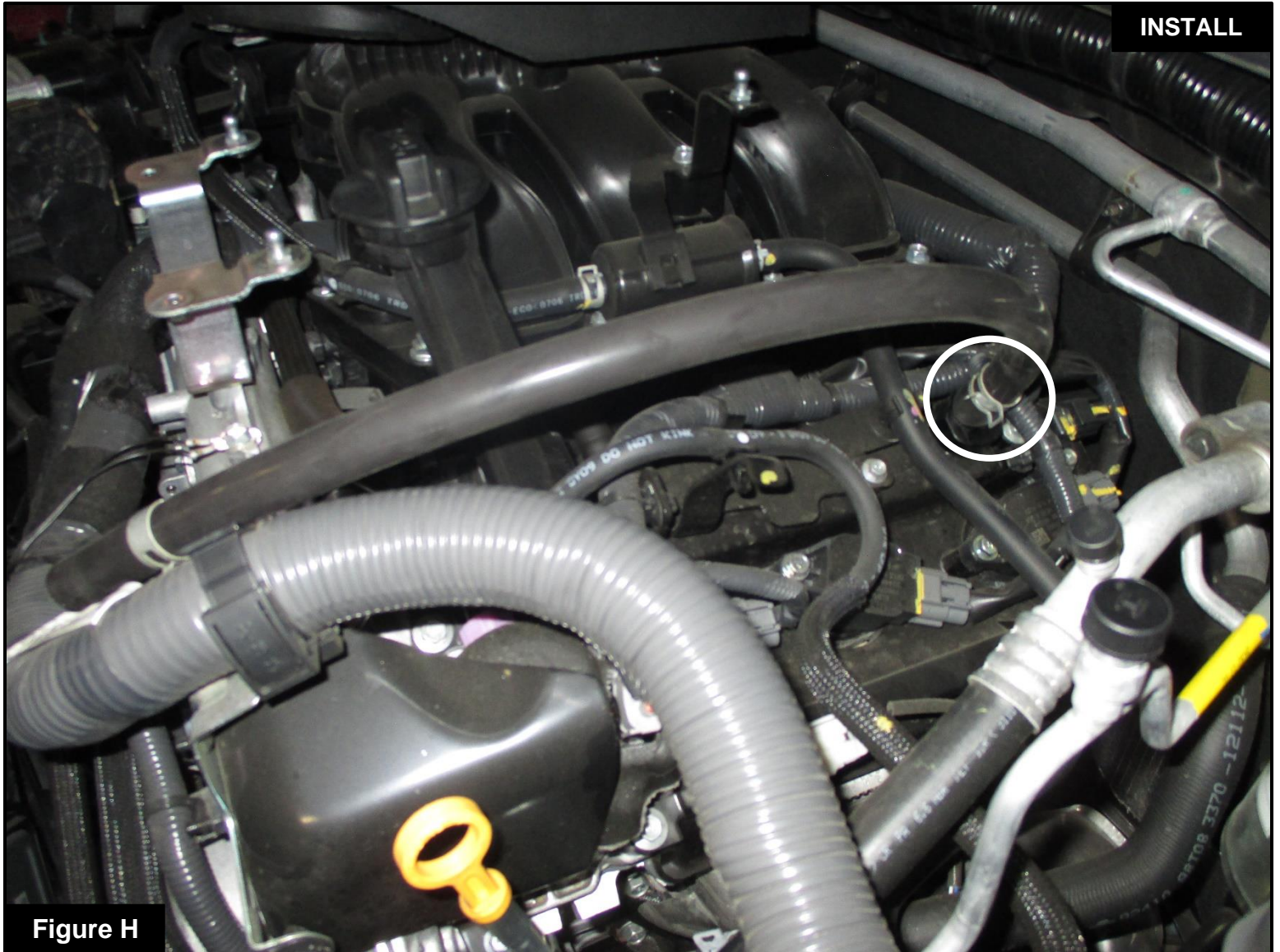
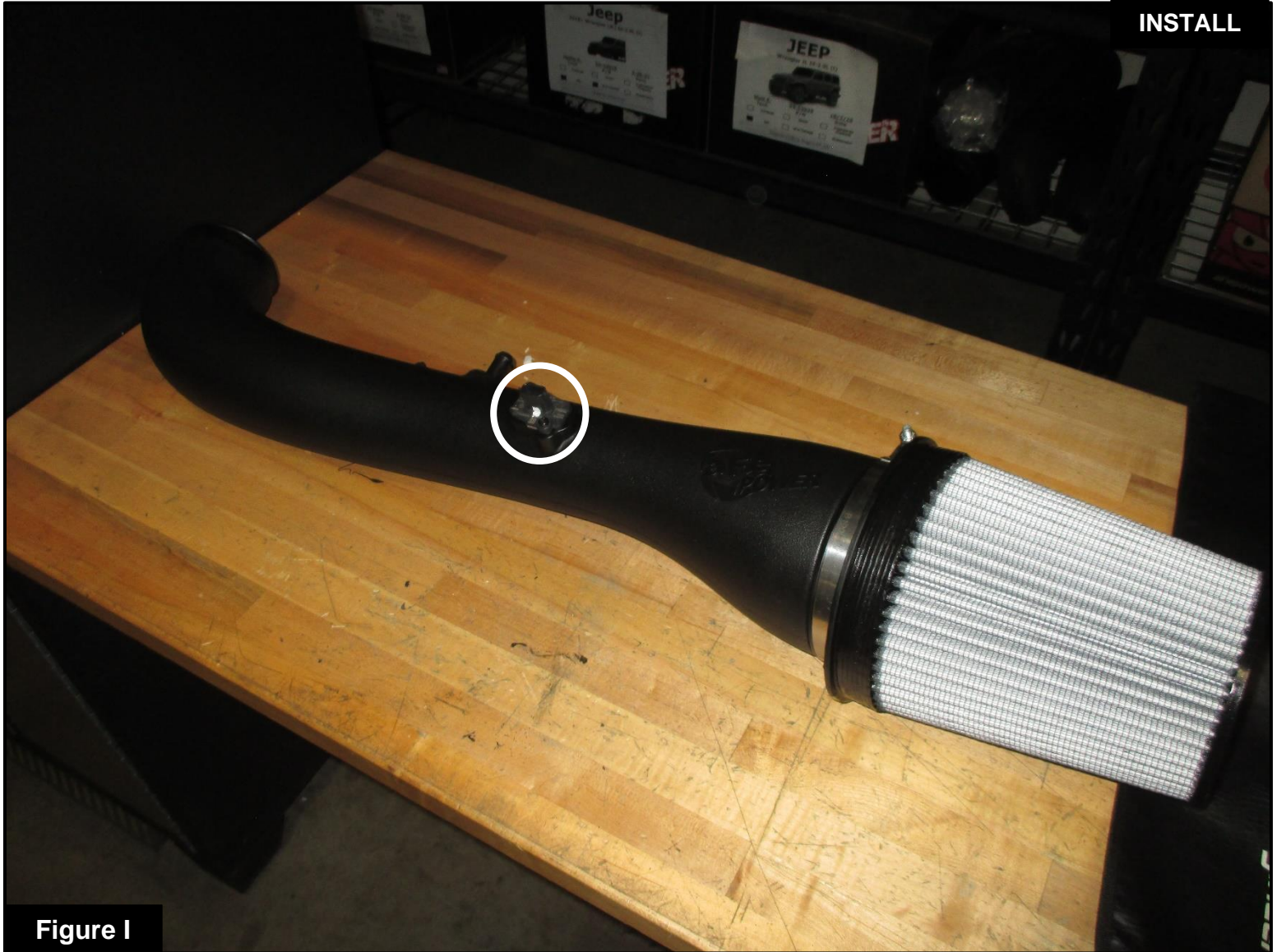

Figure H

**Refer to Figure H for Step 15**

Step 15: Install the supplied hose and one (1) supplied spring clamp onto the engine's CCV opening.

**Figure I****Refer to Figure I for Steps 16-17**

Step 16: Transfer the MAF sensor from the factory intake airbox to the aFe POWER intake tube, and secure it using the supplied M4 screws.

Step 17: Install the supplied air filter onto the aFe POWER intake tube. Tighten the clamp.



**Refer to Figure J for Steps 18-20**

Step 18: Install the pre-assembled aFe POWER intake tube and air filter into the aFe POWER housing then into the coupling.

Step 19: Adjust the aFe POWER intake tube between the coupling and the air filter, then tighten the clamps at both ends, on the throttle body side and on the aFe POWER housing side.

Step 20: Using the remaining supplied spring clamp, connect the open end of the hose from Step 15 to the aFe POWER intake tube.

**Figure K****Refer to Figure K for Steps 21-23**

Step 21: Connect the MAF sensor to the harness.

Step 22: Re-install the engine cover.

Step 23: Make sure all components and connections are secure. Your installation is now complete. Thank you for choosing aFe POWER!

**NOTE: Check all bolts, clamps, and connectors after 100-200 miles.**



**Page left blank intentionally.**



***advanced FLOW engineering, inc.***

252 Granite Street Corona, CA 92879

<https://afepower.com/contact>