



INSTALLATION INSTRUCTIONS

Cat-Back Exhaust

MAKE: Lexus
MODEL: GX460
YEAR: 2010-2023
ENGINE: V8-4.6L

49-36048-P
49-36048-B

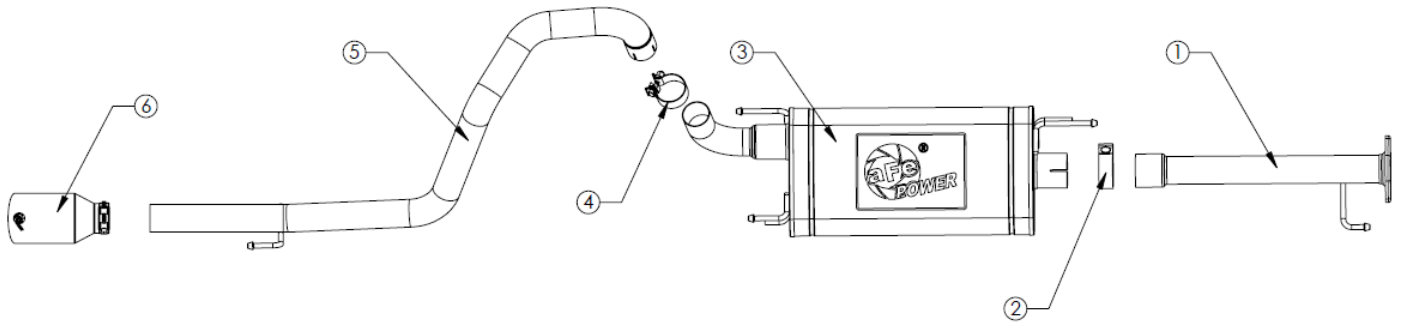

Item	Description	Part Number	Quantity
1	Front Pipe Assembly	05-44863	1
2	3" Band Clamp	05-41055	1
3	Muffler Assembly	05-245164	1
4	2-1/2" Band Clamp	05-41061	1
5	Over-Axle Assembly	05-245126	1
6	Clamp-on Polished Tip Clamp-on Black Tip	49T25454-P091 49T25454-B091	1

aFe POWER recommends professional installation on this product. Thoroughly inspect the aFe POWER exhaust system to make sure there is no damage from shipping (if damage is noted, immediately contact aFe POWER customer service). Allow time for your vehicle to cool down prior to installation. When working on your vehicle proceed with caution. Wear protective safety equipment; eye goggles and gloves to ensure a safe installation.

Install band clamps to proper torque specifications of 40-45 ft-lb.





INSTALLATION INSTRUCTIONS

MAKE: Lexus
MODEL: GX460
YEAR: 2010-2021
ENGINE: V8-4.6L

Cat-Back Exhaust

49-36048-P

49-36048-B

1. **(Read instructions prior to installation.)** It is recommended to not fully tighten the exhaust until it has been fully installed. Leave loose for adjustability.
2. Secure vehicle on jack stands (refer to your manual for specified jack stand positions).
3. For faster installation, spread out the parts of the exhaust alongside your vehicle as shown in the diagram above.
4. Secure the stock exhaust with jack/stands.
5. Remove your stock exhaust up to the Y-pipe containing the catalytic converters from the rear of the vehicle working your way forward. Remove factory rubber isolation mounts and transfer them onto the aFe POWER exhaust system.
6. Install the aFe POWER Front Pipe Assembly by the sliding the (x1) rubber isolation mount to frame hanger and using the (x2) OE flange spring bolts.
7. Install the aFe POWER Muffler Assembly onto the Front Pipe Assembly using the supplied 3" Band Clamp and sliding the (x3) rubber isolation mounts onto the frame hangers.
8. Install the aFe POWER Over-Axle Assembly onto the Muffler Assembly using the supplied 2.5" Band Clamp and sliding the (x1) rubber isolation mount onto rear frame hanger.
9. Install Clamp-on Tip onto the Over-Axle Assembly using supplied clamp.
10. Ensure that all the components of the aFe POWER exhaust system are aligned and are at a safe clearance from all wires, hoses, brake lines, body parts, and tires.
11. Start from the front of the aFe POWER exhaust system and evenly tighten all clamps and fasteners.
12. Start the vehicle and check for any leaks. If any leaks are found, determine cause and repair as necessary.
13. Remove vehicle from jacks stands.
14. It is recommended to re-tighten all clamps and hardware after 50-100 miles.